

NOTES:

1. ALLOWABLE OPTICAL MATERIAL:  
SCHOTT: ZERODUR 542/562
2. SURFACE S2 TO BE PARALLEL WITH SURFACE S1 TO < 3 ARCMIN
3. COATING (APPLY ACROSS COATING APERTURE)

S1: PROTECTED ALUMINUM  
Ravg ≥ 85% 400-700nm @ 0° AOI

S2: NONE

4. ARROW ON EDGE POINTING TOWARDS SURFACE S1.

5. FINE GROUND SURFACE

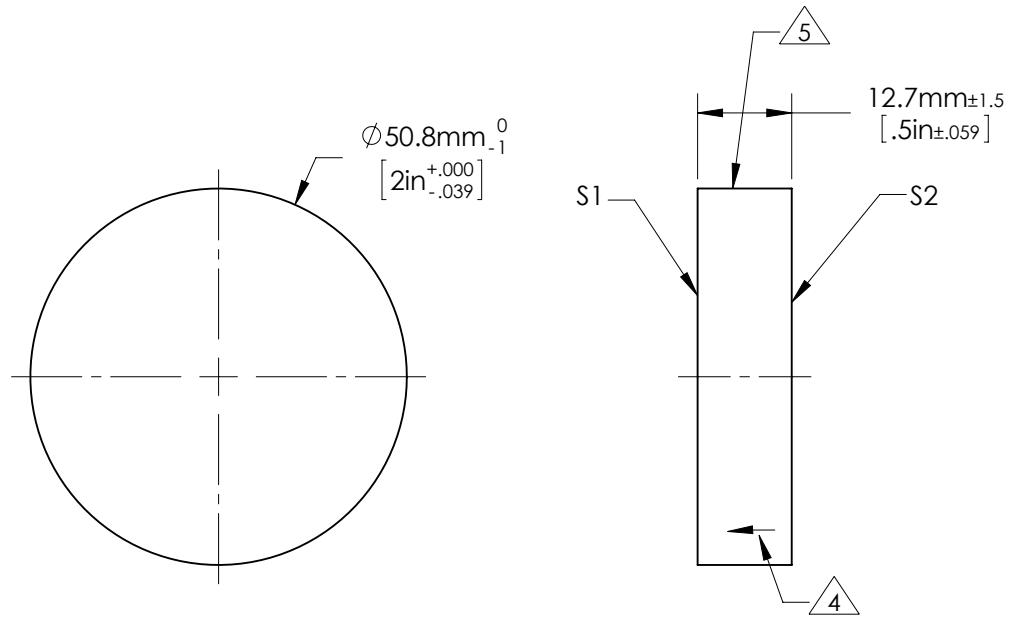

**FOR INFORMATION ONLY:  
DO NOT MANUFACTURE PARTS TO THIS DRAWING**

	S1	S2	EFL (AT 587.6nm)	NA	 <b>Edmund Optics®</b>	
SHAPE	PLANO	PLANO				
SURFACE ACCURACY AT 632.8nm	1/20 WAVE	NA	BFL (AT 587.6nm)	NA	TITLE	1/20λ Optical Flat, Zerodur, 2inch Diameter PROTECTED ALUMINUM
SURFACE QUALITY	60 - 40	COMMERCIAL POLISH			DWG NO	43420-522
CLEAR APERTURE	∅ 45.7	∅ 45.7	ALL DIMS IN	mm		
BEVEL MAX FACE	1.0 x 45°	1.0 x 45°				