

NOTES:

1. SUBSTRATE:
ELEMENT A: GRADE A FINE ANNEALED
SCHOTT: N-BaK4 569/561

ELEMENT B: GRADE A FINE ANNEALED
SCHOTT: N-SF10 728/284
2. ROHS COMPLIANT
3. CENTERING TOLERANCE (AT 587.6nm):
BEAM DEVIATION (HALF ANGLE): <1 ARCMIN
4. COATING (APPLY ACROSS COATING APERTURE)
S1 & S4:
1/4 WAVE MgF2 @ 550nm
R(AVG) < 1.75% FROM 400-700nm (N-BK7)
S2 & S3: NONE
5. FINE GRIND SURFACE
6. POWER, IRREGULARITY, AND SURFACE QUALITY SPECIFICATIONS APPLY ACROSS CLEAR APERTURE
7. FOCAL LENGTH (EFL): 300.00mm ±2%
BACK FOCAL LENGTH (BFL): 293.63mm
8. PROTECTIVE BEVEL AS NEEDED
9. DESIGN WAVELENGTH: 587.6nm
10. ELEMENTS TO BE CEMENTED WITH NORLAND OPTICAL ADHESIVE NOA61

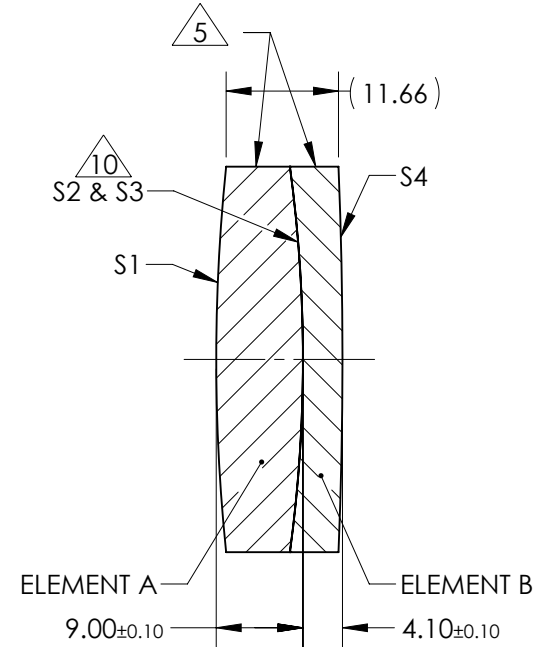
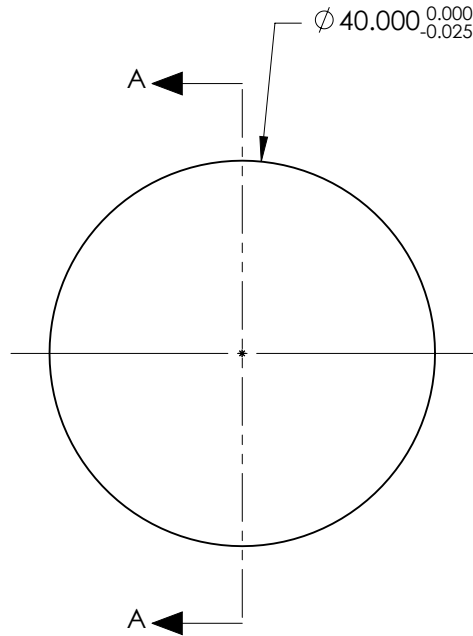

SECTION A-A

**FOR INFORMATION ONLY:
DO NOT MANUFACTURE
PARTS TO THIS DRAWING**

SPECIFICATIONS SUBJECT TO CHANGE WITHOUT NOTICE
DIMENSIONS ARE FOR REFERENCE ONLY

ELEMENT TITLE	SPECIFICATIONS AFTER CEMENTING			
	ELEMENT A		ELEMENT B	
SURFACE	S1	S2	S3	S4
SHAPE	CONVEX	CONVEX	CONCAVE	CONVEX
RADIUS	194.96	148.27	148.27	483.71
SURFACE QUALITY	40 - 20	40 - 20	40 - 20	40 - 20
MIN CLEAR APERTURE	Ø 39.00	Ø 39.00	Ø 39.00	Ø 39.00
MIN COATING APERTURE	Ø 39.00	N/A	N/A	Ø 39.00
POWER AT 632.8nm	3.00 RINGS	3.00 RINGS	3.00 RINGS	3.00 RINGS
IRREGULARITY AT 632.8nm	0.50 RINGS	0.50 RINGS	0.50 RINGS	0.50 RINGS

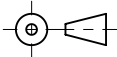
THIRD ANGLE PROJECTION 

ALL DIMS IN mm

EO® Edmund Optics®

TITLE: 40mm Dia. x 300mm FL, MgF2 Coated, Achromatic Doublet Lens

DWG NO: 45178

SHEET 1 OF 1