

NOTES:

1. SUBSTRATE:
GRADE A FINE ANNEALED
SCHOTT: N-BK7 517/642
2. ROHS COMPLIANT
3. CENTERING TOLERANCE (AT 587.6nm):
BEAM DEVIATION (HALF ANGLE): <1 ARCMIN
4. COATING (APPLY ACROSS COATING APERTURE)
S1 & S2: VIS-NIR
R(ABS) ≤ 0.25% AT 880nm @ 0° AOI
R(AVG) ≤ 1.25% FROM 400-870nm @ 0° AOI
R(AVG) ≤ 1.25% FROM 890-1000nm @ 0° AOI
5. FINE GRIND SURFACE
6. POWER, IRREGULARITY, AND SURFACE QUALITY SPECIFICATIONS APPLY ACROSS CLEAR APERTURE
7. FOCAL LENGTH (EFL): 60.00mm±1%
BACK FOCAL LENGTH (BFL): 57.03mm
8. PROTECTIVE BEVEL AS NEEDED
9. DESIGN WAVELENGTH: 587.6nm

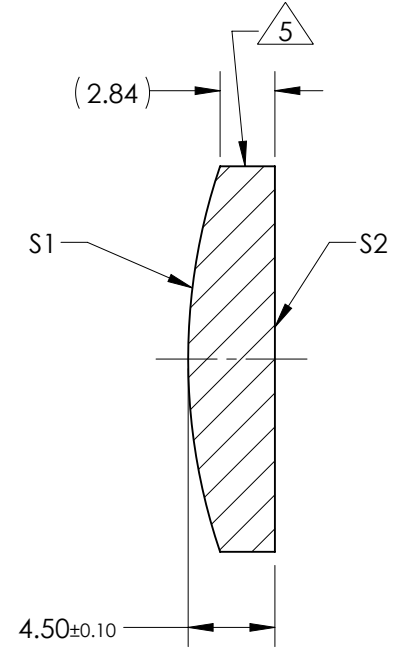
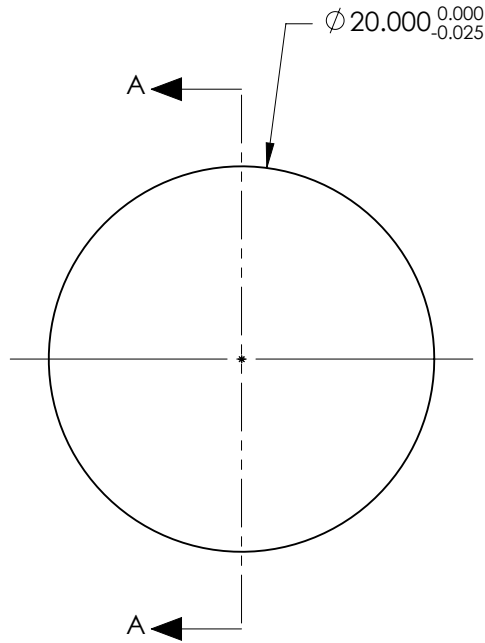

SECTION A-A

**FOR INFORMATION ONLY:
DO NOT MANUFACTURE
PARTS TO THIS DRAWING**

	S1	S2
SHAPE	CONVEX	PLANO
RADIUS	31.01	INFINITY
SURFACE QUALITY	40 - 20	40 - 20
MIN CLEAR APERTURE	∅ 19.00	∅ 19.00
MIN COATING APERTURE	∅ 19.00	∅ 19.00
POWER AT 632.8nm	3.00 RINGS	3.00 RINGS
IRREGULARITY AT 632.8nm	0.50 RINGS	0.50 RINGS

SPECIFICATIONS SUBJECT TO CHANGE WITHOUT NOTICE
DIMENSIONS ARE FOR REFERENCE ONLY

EO® Edmund Optics®

THIRD ANGLE PROJECTION		TITLE	20.0mm Dia. x 60.0mm FL, VIS-NIR Coated, Plano-Convex Lens
ALL DIMS IN	mm	DWG NO	45502
			SHEET 1 OF 1