

NOTES:

1. SUBSTRATE:
GRADE A FINE ANNEALED
SCHOTT: N-BK7 517/642
2. ROHS COMPLIANT
3. CENTERING TOLERANCE (AT 587.6nm):
BEAM DEVIATION (HALF ANGLE): <1 ARCMIN
4. COATING (APPLY ACROSS COATING APERTURE)
S1 & S2: VIS 0°
R(AVG) ≤ 0.4% FROM 425-675nm @ 0° AOI
5. FINE GRIND SURFACE
6. POWER, IRREGULARITY, AND SURFACE QUALITY SPECIFICATIONS APPLY ACROSS CLEAR APERTURE
7. FOCAL LENGTH (EFL): 40.00mm±1%
BACK FOCAL LENGTH (BFL): 38.44mm
8. PROTECTIVE BEVEL AS NEEDED
9. DESIGN WAVELENGTH: 587.6nm

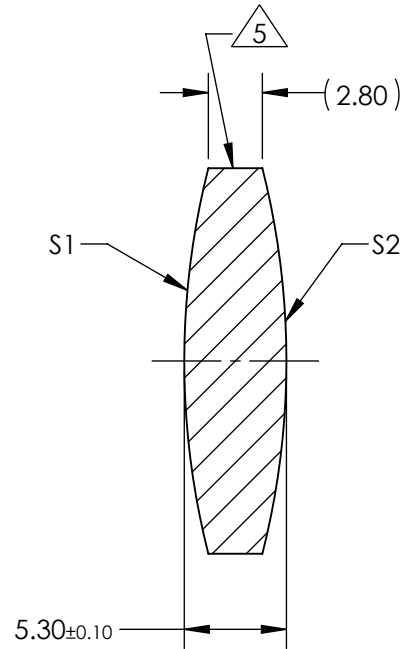
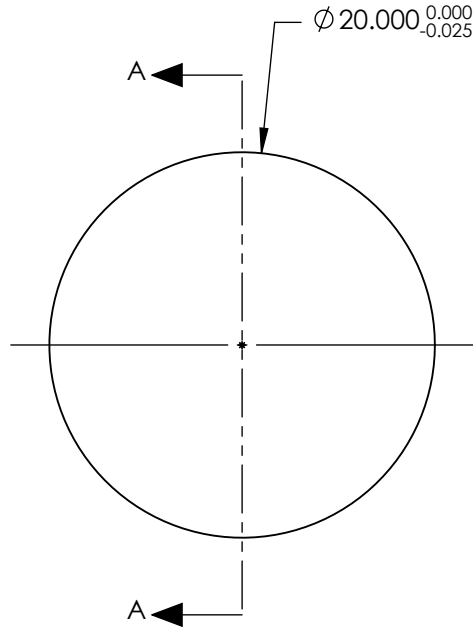

SECTION A-A

**FOR INFORMATION ONLY:
DO NOT MANUFACTURE
PARTS TO THIS DRAWING**

| | S1 | S2 |
|-------------------------|------------|------------|
| SHAPE | CONVEX | CONVEX |
| RADIUS | 40.67 | 40.67 |
| SURFACE QUALITY | 40 - 20 | 40 - 20 |
| MIN CLEAR APERTURE | ∅ 19.00 | ∅ 19.00 |
| MIN COATING APERTURE | ∅ 19.00 | ∅ 19.00 |
| POWER AT 632.8nm | 3.00 RINGS | 3.00 RINGS |
| IRREGULARITY AT 632.8nm | 0.50 RINGS | 0.50 RINGS |

SPECIFICATIONS SUBJECT TO CHANGE WITHOUT NOTICE
DIMENSIONS ARE FOR REFERENCE ONLY

EO® Edmund Optics®

| | | | |
|------------------------|----|--------|--|
| THIRD ANGLE PROJECTION | | TITLE | 20mm Dia. x 40mm FL, VIS 0 Coated, Double-Convex Lens |
| ALL DIMS IN | mm | DWG NO | 47904 |
| | | | SHEET 1 OF 1 |