

SPECIFICATIONS SUBJECT TO CHANGE WITHOUT NOTICE
 DIMENSIONS ARE FOR REFERENCE ONLY
 DIMENSIONS ARE IN mm [INCHES]

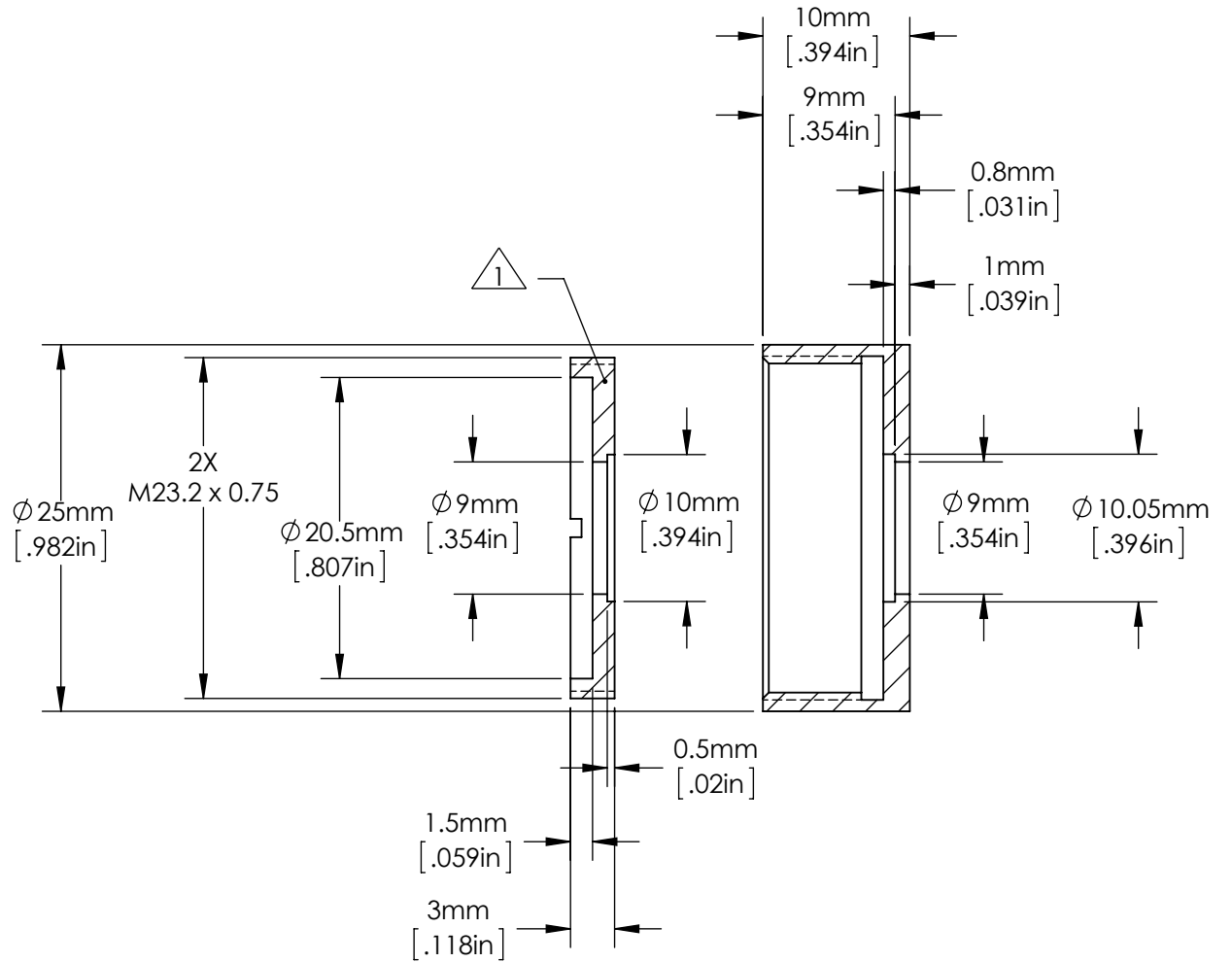
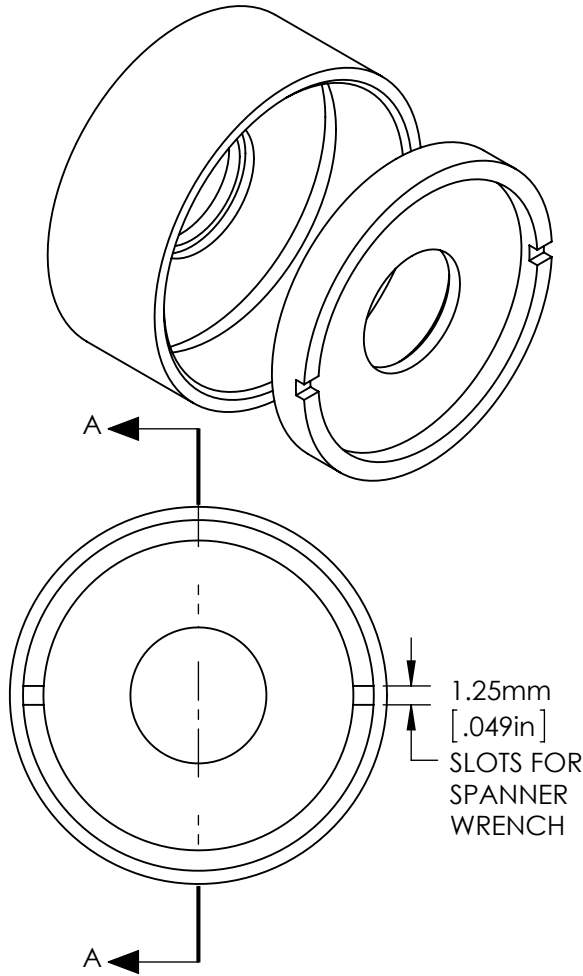

SECTION A-A

NOTES:

1. ADDITIONAL RETAINING RINGS CAN BE PURCHASED IN PAIRS AS SN 85563.



Edmund Optics®

TITLE	25mm Cage 10mm Diameter Lens Mount				
DWG NO	85551	MATERIAL	BLACK ANODIZED ALUMINUM	SHEET 1 OF 1	REV 000