

**FOR INFORMATION ONLY:
DO NOT MANUFACTURE
PARTS TO THIS DRAWING**

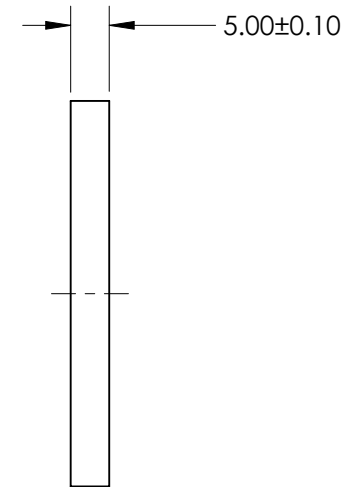
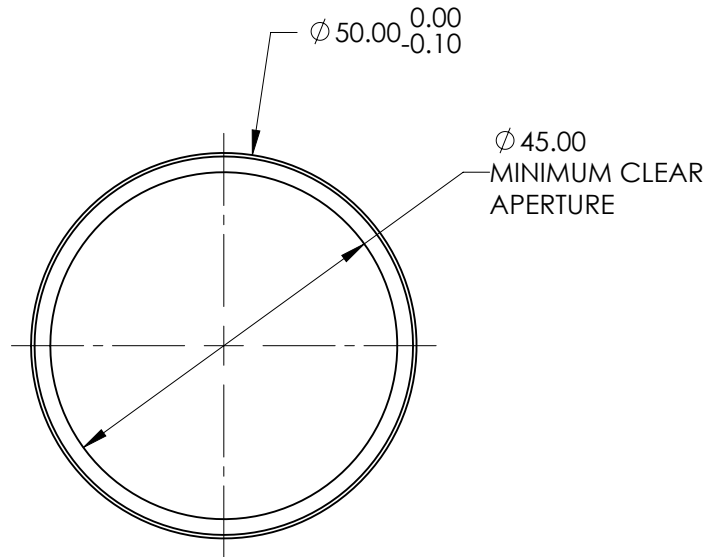
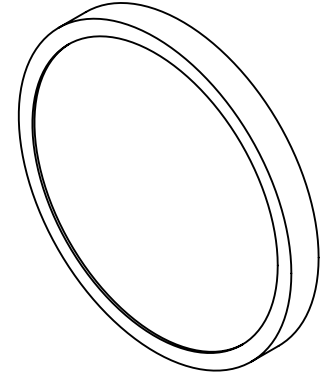
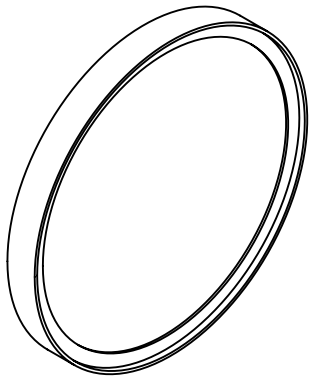

SPECIFICATION	VALUE
CENTER WAVELENGTH (CWL)	1500nm ± 5nm
FULL WIDTH HALF MAX (FWHM)	50nm ± 5nm
MINIMUM TRANSMISSION	>90%
BLOCKING	OD > 4.0 FROM 200 TO 1800nm
SURFACE QUALITY	80 - 50
CONSTRUCTION	MOUNTED IN BLACK ANODIZED ALUMINUM RING
COATING TYPE	HARD COATED
DURABILITY	MIL-C-48497A, SECT. 3.4.1
ENVIRONMENTAL	MIL-STD-810F, SECT. 507.4

SPECIFICATIONS SUBJECT TO CHANGE WITHOUT NOTICE
DIMENSIONS ARE FOR REFERENCE ONLY

EFL (AT 587.6nm)	NA	 Edmund Optics®	
BFL (AT 587.6nm)	NA	TITLE	1500nm CWL, 50mm Dia. Hard Coated OD4 50nm Bandpass Filter
ALL DIMS IN	mm	DWG NO	85914
			SHEET 1 OF 1