

**FOR INFORMATION ONLY:
DO NOT MANUFACTURE
PARTS TO THIS DRAWING**

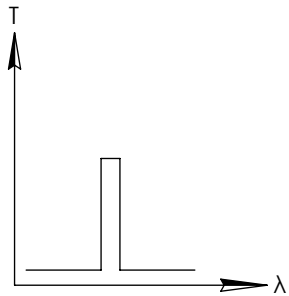
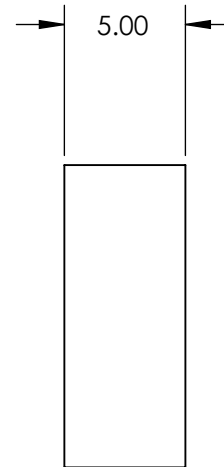
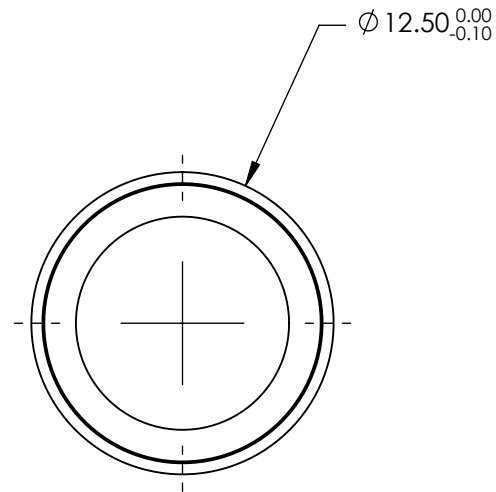
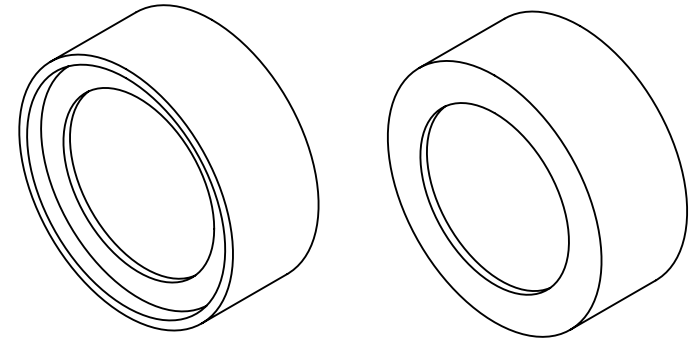

BANDPASS FILTER

REV. A	VALUE
CENTER WAVELENGTH (CWL)	1300 ± 3 nm
FULL WIDTH HALF MAX (FWHM)	25 ± 3 nm
MINIMUM TRANSMISSION	>90
BLOCKING	200 - 1800nm
SURFACE QUALITY	80-50
COATING TYPE	HARD COATED
DURABILITY	MIL-C-48497A
ENVIRONMENTAL	MIL-STD-810F

SPECIFICATIONS SUBJECT TO CHANGE WITHOUT NOTICE
DIMENSIONS ARE FOR REFERENCE ONLY



ALL DIMS IN

mm

TITLE

OD4, Ø12.5mm, 1300nm x 25nm, HD
BANDPASS FILTER

DWG NO

87817

SHEET
1 OF 1