

NOTES:

1. SUBSTRATE: UV GRADE FUSED SILICA
2. SURFACE S2 TO BE PARALLEL WITH SURFACE S1 TO WITHIN <30 arcsec
3. COATING (APPLY ACROSS COATING APERTURE)  
 DURABILITY: MIL-C-48497A, SECT. 3.4.1  
 PERFORMANCE SPECIFICATIONS: @ 0° AOI  
 T(avg): ≥91% FROM 510 - 1085nm  
 T(avg): ≤ 0.01% FROM 1140 - 1530nm  
 CUT-OFF SLOPE: <1%  
 CUT-OFF WAVELENGTH: 1100nm ± 1%

FOR INFORMATION ONLY:  
DO NOT MANUFACTURE  
PARTS TO THIS DRAWING

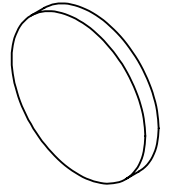

4. FINE GRIND SURFACE

5. POWER, IRREGULARITY, AND SURFACE QUALITY SPECIFICATIONS APPLY ACROSS CLEAR APERTURE
6. TRANSMITTED WAVEFRONT DISTORTION RMS@ 632.8nm ≤ ¼ λ
7. ROHS COMPLIANT

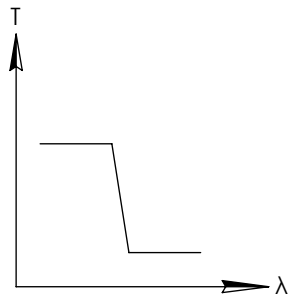
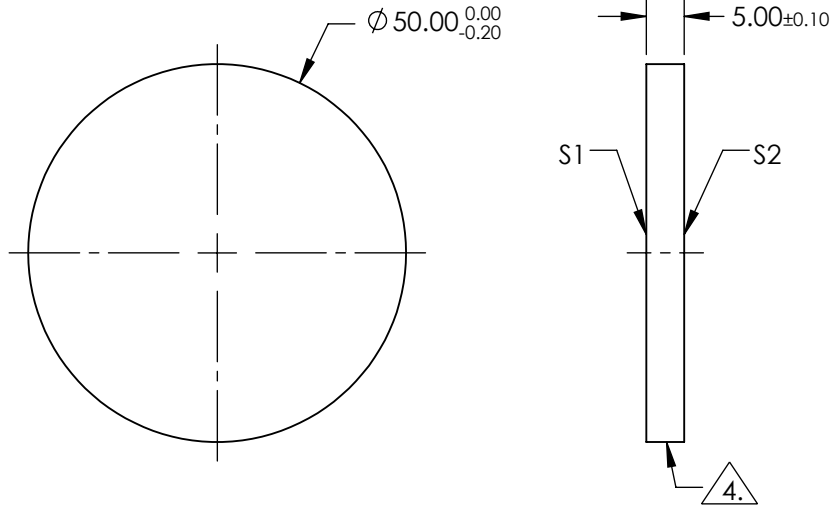

SHORTPASS FILTER

SPECIFICATIONS SUBJECT TO CHANGE WITHOUT NOTICE  
DIMENSIONS ARE FOR REFERENCE ONLY

**EO**® Edmund Optics®

	S1	S2
SHAPE	PLANO	PLANO
SURFACE QUALITY	60-40	60-40
CLEAR APERTURE	>80%	>80%
BEVEL	PROTECTIVE AS NEEDED	PROTECTIVE AS NEEDED

THIRD ANGLE PROJECTION

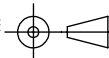

ALL DIMS IN

mm

TITLE	1100nm 50mm Diameter, OD 4 Shortpass Filter
DWG NO	84735
SHEET	1 OF 1