

NOTES:

**FOR INFORMATION ONLY:
DO NOT MANUFACTURE
PARTS TO THIS DRAWING**

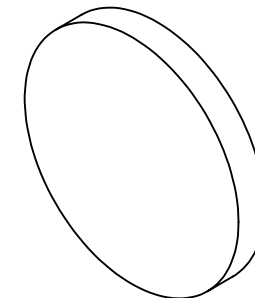

1. SUBSTRATE
2. SURFACE S2 TO BE PARALLEL WITH SURFACE S1 TO WITHIN ± 3 arcsec
3. COATING (APPLY ACROSS COATING APERTURE)
DURABILITY:
PERFORMANCE SPECIFICATIONS:
T(avg): >85% @ 0° AOI FROM 400 - 530nm
T(avg): <1% @ 0° AOI FROM 575 - 725nm
T(avg): =50% FOR 0° AOI @ 550nm $\pm 2\%$

S2: SINGLE LAYER MgF2

4. FINE GRIND SURFACE

5. POWER, IRREGULARITY, AND SURFACE QUALITY SPECIFICATIONS APPLY ACROSS CLEAR APERTURE
6. TRANSMITTED WAVEFRONT DISTORTION P-V @ 632.8nm 1/10 λ
7. ROHS COMPLIANT

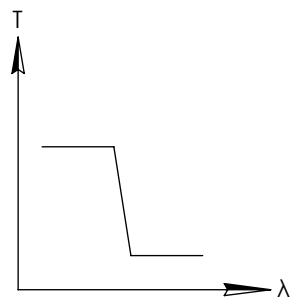
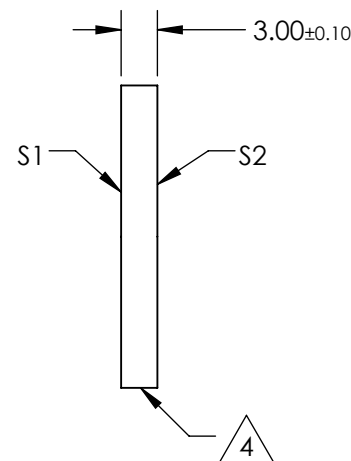
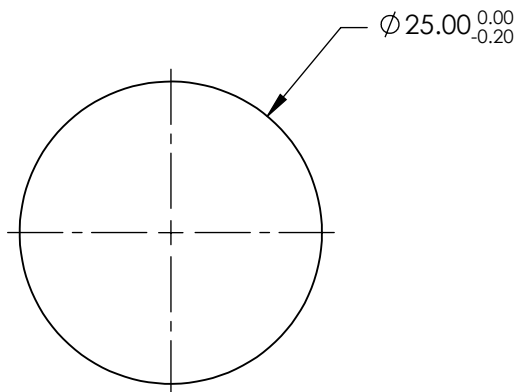

SHORTPASS FILTER

SPECIFICATIONS SUBJECT TO CHANGE WITHOUT NOTICE
DIMENSIONS ARE FOR REFERENCE ONLY

Rev. A	S1	S2
SHAPE	PLANO	PLANO
SURFACE QUALITY	40-20	40-20
CLEAR APERTURE	80%	80%
BEVEL	PROTECTIVE AS NEEDED	PROTECTIVE AS NEEDED

THIRD ANGLE PROJECTION

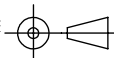

ALL DIMS IN

mm

EO® Edmund Optics®

TITLE

OD2, Ø25mm, 550nm, SHORTPASS FILTER

DWG NO

47288

SHEET
1 OF 1