

NOTES:

**FOR INFORMATION ONLY:
DO NOT MANUFACTURE
PARTS TO THIS DRAWING**

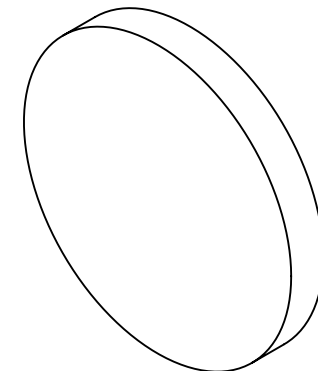

1. SUBSTRATE
2. SURFACE S2 TO BE PARALLEL WITH SURFACE S1 TO WITHIN ± 3 arcsec
3. COATING (APPLY ACROSS COATING APERTURE)
DURABILITY:
PERFORMANCE SPECIFICATIONS:
T(avg): $>85\%$ @ AOI 0° FROM 250 - 505nm
T(avg): $<1\%$ @ AOI 0° FROM 545 - 635nm
T(avg): $=50\%$ FOR AOI 0° @ 525 ± 2 nm

S2: SINGLE LAYER MgF2

4. FINE GRIND SURFACE

5. POWER, IRREGULARITY, AND SURFACE QUALITY SPECIFICATIONS APPLY ACROSS CLEAR APERTURE
6. TRANSMITTED WAVEFRONT DISTORTION @ P-V @ 632.8nm $1/10 \lambda$
7. ROHS COMPLIANT

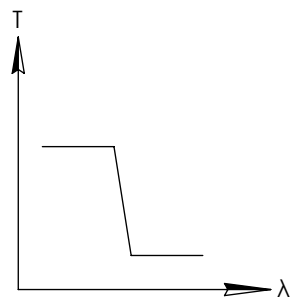
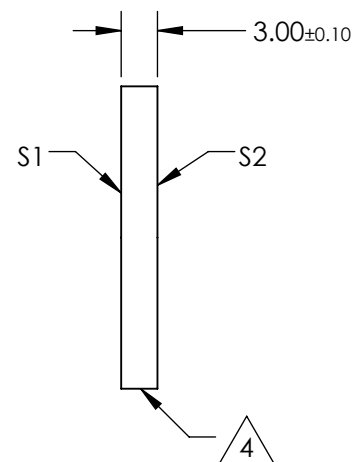
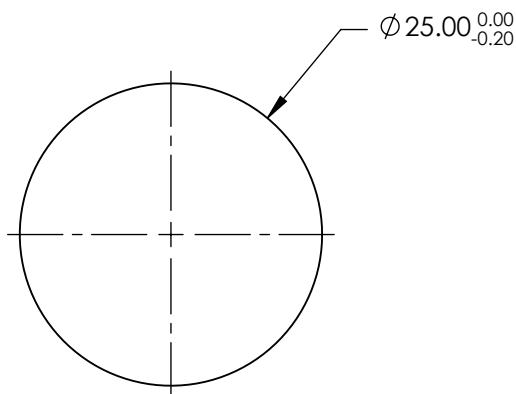

SHORTPASS FILTER

SPECIFICATIONS SUBJECT TO CHANGE WITHOUT NOTICE
DIMENSIONS ARE FOR REFERENCE ONLY

Rev. A	S1	S2
SHAPE	PLANO	PLANO
SURFACE QUALITY	40-20	40-20
CLEAR APERTURE	80%	80%
BEVEL	PROTECTIVE AS NEEDED	PROTECTIVE AS NEEDED

THIRD ANGLE PROJECTION

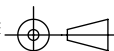

ALL DIMS IN

mm

EO® Edmund Optics®

TITLE

OD2, Ø25mm, 525nm, SHORTPASS FILTER

DWG NO

64602

SHEET
1 OF 1