

NOTES:

1. SUBSTRATE:
CORNING: FUSED SILICA 458/678
2. ROHS COMPLIANT
3. CENTERING TOLERANCE (AT 587.6nm):
BEAM DEVIATION (HALF ANGLE): <1 ARCMIN
4. COATING (APPLY ACROSS COATING APERTURE)
S1 & S2: 532nm V-COAT
R(ABS) < 0.25% @ 532nm @ 0° AOI
5. FINE GRIND SURFACE
6. POWER, IRREGULARITY, AND SURFACE QUALITY SPECIFICATIONS APPLY ACROSS CLEAR APERTURE
7. FOCAL LENGTH (EFL): 50.00mm±1%
BACK FOCAL LENGTH (BFL): 48.01mm
8. PROTECTIVE BEVEL AS NEEDED
9. DESIGN WAVELENGTH: 532nm

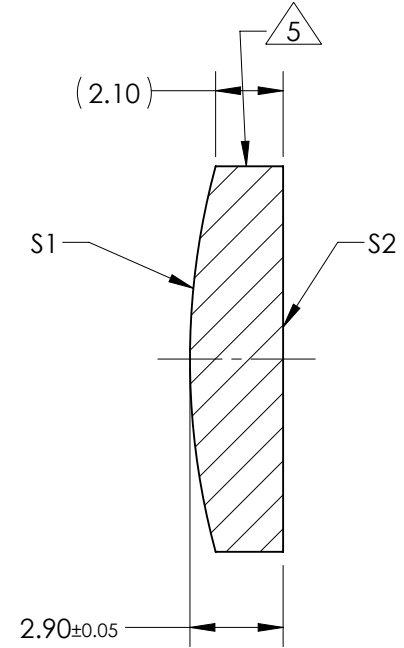
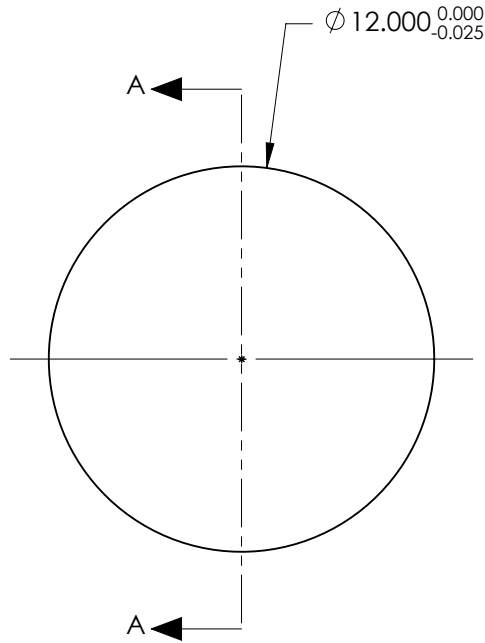

SECTION A-A

**FOR INFORMATION ONLY:
DO NOT MANUFACTURE
PARTS TO THIS DRAWING**

| | S1 | S2 |
|-------------------------|------------|------------|
| SHAPE | CONVEX | PLANO |
| RADIUS | 22.92 | INFINITY |
| SURFACE QUALITY | 40 - 20 | 40 - 20 |
| MIN CLEAR APERTURE | ∅ 11.00 | ∅ 11.00 |
| MIN COATING APERTURE | ∅ 11.00 | ∅ 11.00 |
| POWER AT 632.8nm | 3.00 RINGS | 3.00 RINGS |
| IRREGULARITY AT 632.8nm | 0.50 RINGS | 0.50 RINGS |

SPECIFICATIONS SUBJECT TO CHANGE WITHOUT NOTICE
DIMENSIONS ARE FOR REFERENCE ONLY

EO® Edmund Optics®

| | | | |
|------------------------|----|--------|---|
| THIRD ANGLE PROJECTION | | TITLE | 12mm Dia. x 50mm FL 532nm V-Coat, UV PCX Lens |
| ALL DIMS IN | mm | DWG NO | 34091 |
| | | | SHEET 1 OF 1 |