

NOTES:

1. SUBSTRATE:
GRADE A FINE ANNEALED
SCHOTT: N-SF11 785/258
2. ROHS COMPLIANT
3. CENTERING TOLERANCE (AT 587.6nm):
BEAM DEVIATION (HALF ANGLE): <3 ARCMIN
4. COATING (APPLY ACROSS COATING APERTURE)
S1 & S2: 1310nm V-COAT
R(ABS) < 0.25% @ 1310nm @ 0° AOI
5. FINE GRIND SURFACE
6. POWER, IRREGULARITY, AND SURFACE QUALITY SPECIFICATIONS APPLY ACROSS CLEAR APERTURE
7. FOCAL LENGTH (EFL): 9.00mm ±1%
BACK FOCAL LENGTH (BFL): 7.32mm
8. PROTECTIVE BEVEL AS NEEDED
9. DESIGN WAVELENGTH: 587.6nm

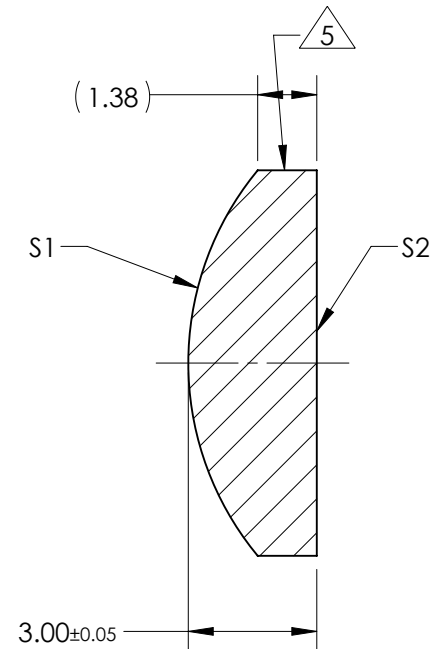
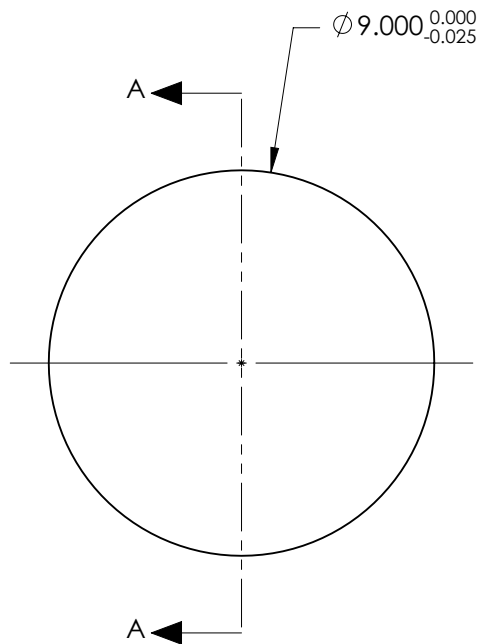

SECTION A-A

***FOR INFORMATION ONLY:
DO NOT MANUFACTURE
PARTS TO THIS DRAWING***

	S1	S2
SHAPE	CONVEX	PLANO
RADIUS	7.06	INFINITY
SURFACE QUALITY	40 - 20	40 - 20
MIN CLEAR APERTURE	∅8.10	∅8.10
MIN COATING APERTURE	∅8.00	∅8.00
POWER AT 632.8nm	3.00 RINGS	3.00 RINGS
IRREGULARITY AT 632.8nm	0.50 RINGS	0.50 RINGS

SPECIFICATIONS SUBJECT TO CHANGE WITHOUT NOTICE
DIMENSIONS ARE FOR REFERENCE ONLY

EO® **Edmund Optics**®

THIRD ANGLE PROJECTION		TITLE	9.0mm Diameter x 9.0mm FL, 1310nm V-Coat, PCX Lens
ALL DIMS IN	mm	DWG NO	84146
			SHEET 1 OF 1