

NOTES:

1. SUBSTRATE:  
GRADE A FINE ANNEALED  
SCHOTT: N-BK7 517/642
2. ROHS COMPLIANT
3. CENTERING TOLERANCE (AT 587.6nm):  
BEAM DEVIATION (HALF ANGLE): <1 ARCMIN
4. COATING (APPLY ACROSS COATING APERTURE)  
S1 & S2: YAG-BBAR  
R(ABS) < 0.25% @ 532nm @ 0° AOI  
R(ABS) < 0.25% @ 1064nm @ 0° AOI  
R(AVG) < 1.0% FROM 500-1100nm @ 0° AOI
5. FINE GRIND SURFACE
6. POWER, IRREGULARITY, AND SURFACE QUALITY SPECIFICATIONS APPLY ACROSS CLEAR APERTURE
7. FOCAL LENGTH (EFL): 38.10mm±1%  
BACK FOCAL LENGTH (BFL): 36.12mm
8. PROTECTIVE BEVEL AS NEEDED
9. DESIGN WAVELENGTH: 587.6nm

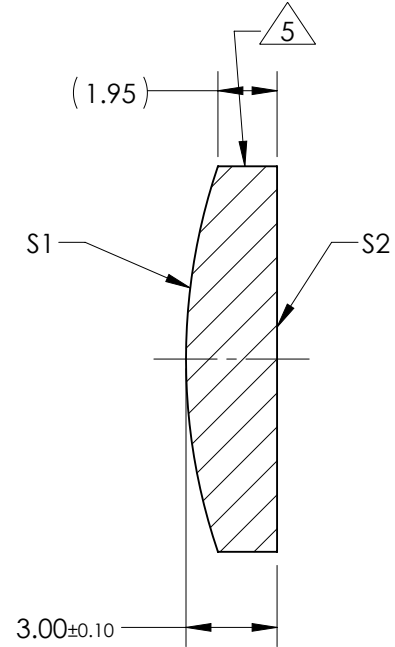
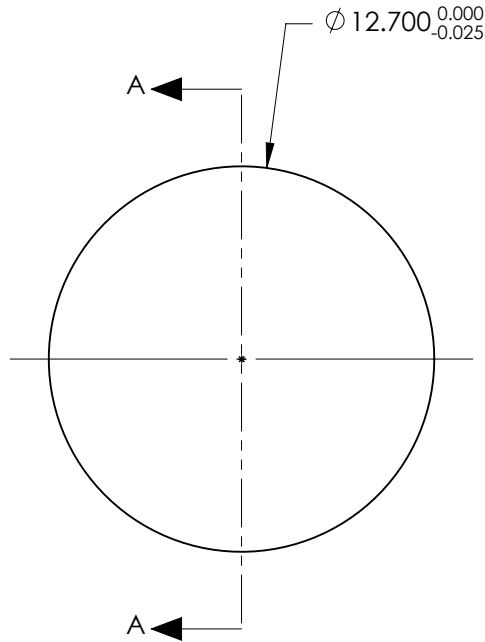

SECTION A-A

**FOR INFORMATION ONLY:  
DO NOT MANUFACTURE  
PARTS TO THIS DRAWING**

	S1	S2
SHAPE	CONVEX	PLANO
RADIUS	19.69	INFINITY
SURFACE QUALITY	40 - 20	40 - 20
MIN CLEAR APERTURE	∅ 11.70	∅ 11.70
MIN COATING APERTURE	∅ 11.70	∅ 11.70
POWER AT 632.8nm	3.00 RINGS	3.00 RINGS
IRREGULARITY AT 632.8nm	0.50 RINGS	0.50 RINGS

SPECIFICATIONS SUBJECT TO CHANGE WITHOUT NOTICE  
DIMENSIONS ARE FOR REFERENCE ONLY

**EO**® **Edmund Optics**®

THIRD ANGLE PROJECTION		TITLE	12.7mm Dia. x 38.1mm FL, YAG-BBAR Coated Plano-Convex Lens
ALL DIMS IN	mm	DWG NO	88849
			SHEET 1 OF 1