

**FOR INFORMATION ONLY:
DO NOT MANUFACTURE
PARTS TO THIS DRAWING**

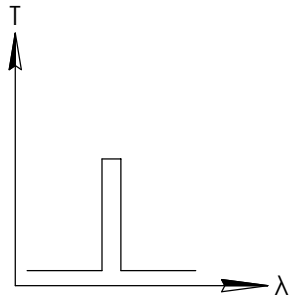
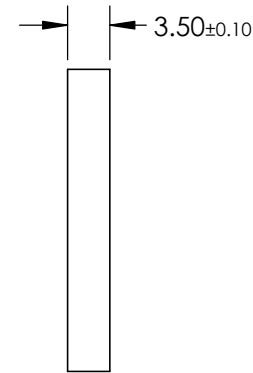
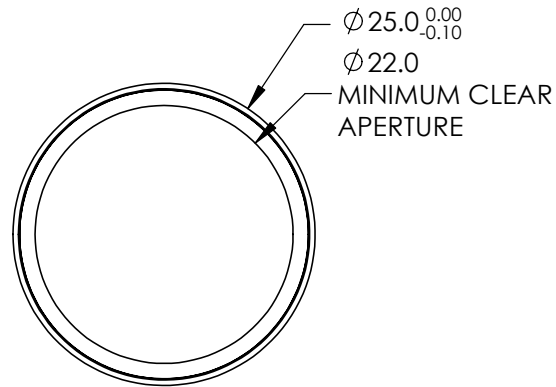
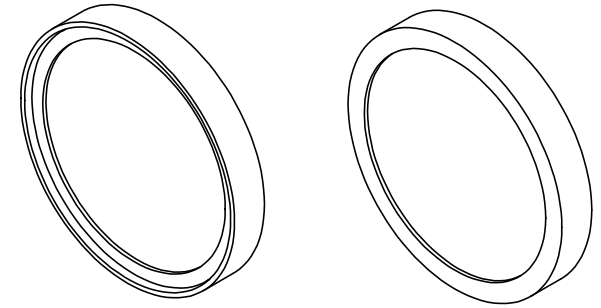

BANDPASS FILTER

REV. A	VALUE
CENTER WAVELENGTH (CWL)	386 ± 2nm
FULL WIDTH HALF MAX (FWHM)	27 ± 2nm
MINIMUM TRANSMISSION	90%
BLOCKING	250 - 1100nm
SURFACE QUALITY	60-40
CONSTRUCTION	MOUNTED IN BLACK ANODIZED ALUMINUM RING
COATING TYPE	HARD COATED
DURABILITY	MIL-C-48497A, SECT. 3.4.1
ENVIRONMENTAL	MIL-STD-801F, SECT. 507.4

SPECIFICATIONS SUBJECT TO CHANGE WITHOUT NOTICE
DIMENSIONS ARE FOR REFERENCE ONLY

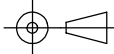

THIRD ANGLE PROJECTION 	TITLE	OD6, Ø25mm, 386nm x 27nm, BP FLUORESCENCE FILTER	
ALL DIMS IN	mm	DWG NO	33321
			SHEET 1 OF 1