

**FOR INFORMATION ONLY:
DO NOT MANUFACTURE
PARTS TO THIS DRAWING**

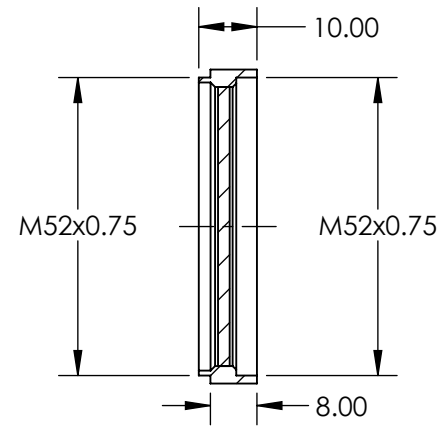

SECTION A-A

SPECIFICATIONS SUBJECT TO CHANGE WITHOUT NOTICE
DIMENSIONS ARE FOR REFERENCE ONLY

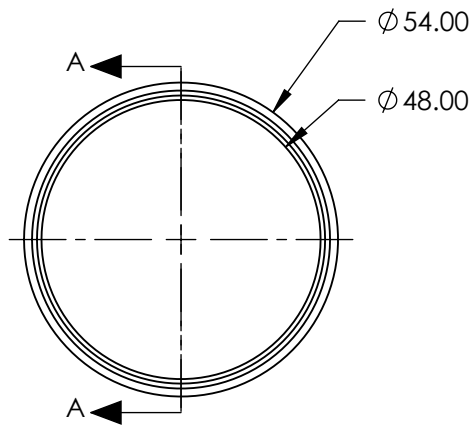

REV. A	VALUE
POLARIZATION EFFICIENCY	95%
TRANSMISSION	SINGLE: 30%; CROSSED: 0.15%

THIRD ANGLE PROJECTION	
ALL DIMS IN	mm

TITLE	M52 x 0.75 MOUNTED LINEAR GLASS POLARIZING FILTER
DWG NO	36441
SHEET	1 OF 1