

**FOR INFORMATION ONLY:
DO NOT MANUFACTURE
PARTS TO THIS DRAWING**

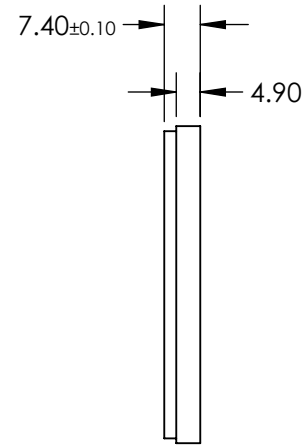
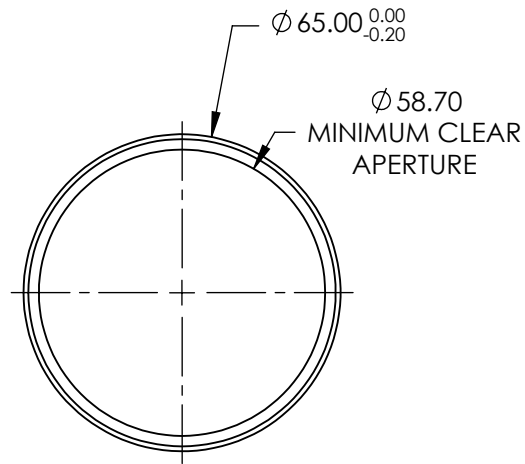
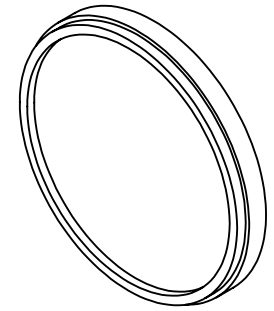
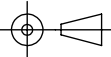

SPECIFICATIONS SUBJECT TO CHANGE WITHOUT NOTICE
DIMENSIONS ARE FOR REFERENCE ONLY

EO[®] **Edmund Optics**[®]

	S1	S2	THIRD ANGLE PROJECTION 		TITLE	M62 X 0.75, MOUNTED THREADED, RED FILTER	
SHAPE	PLANO	PLANO	ALL DIMS IN	mm	DWG NO	46532	SHEET 1 OF 1
SURFACE QUALITY	80-50	80-50					
BEVEL	PROTECTIVE AS NEEDED	PROTECTIVE AS NEEDED					