

**FOR INFORMATION ONLY:
DO NOT MANUFACTURE
PARTS TO THIS DRAWING**

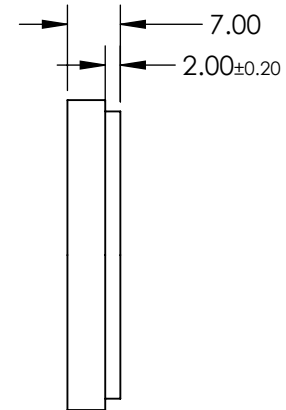
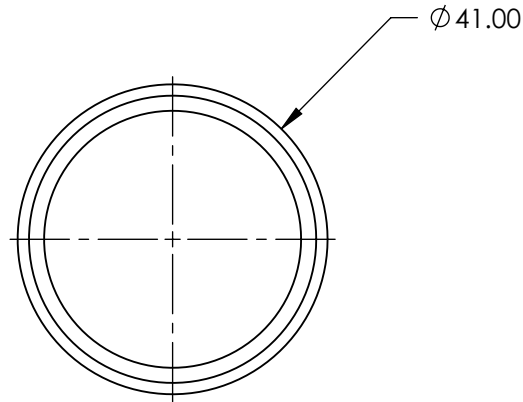
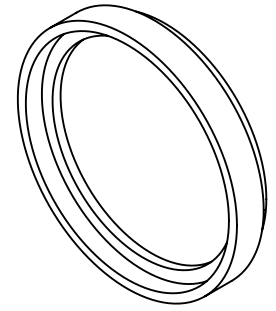
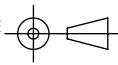

SPECIFICATIONS SUBJECT TO CHANGE WITHOUT NOTICE
DIMENSIONS ARE FOR REFERENCE ONLY

REV. A	VALUE
SHAPE	PLANO
CUT-ON WAVELENGTH	390
SURFACE FLATNESS	4 - 6λ
SURFACE QUALITY	80-50
CLEAR APERTURE	Ø34

THIRD ANGLE PROJECTION 

ALL DIMS IN mm

EO® **Edmund Optics**®

TITLE	M39 X 0.5 MOUNTED, UV CUT-OFF FILTER
DWG NO	46579
	SHEET 1 OF 1