

**FOR INFORMATION ONLY:  
DO NOT MANUFACTURE  
PARTS TO THIS DRAWING**

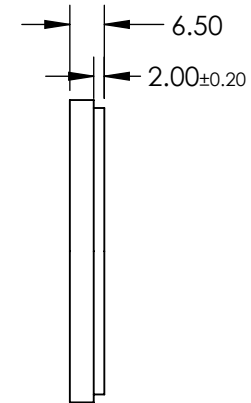
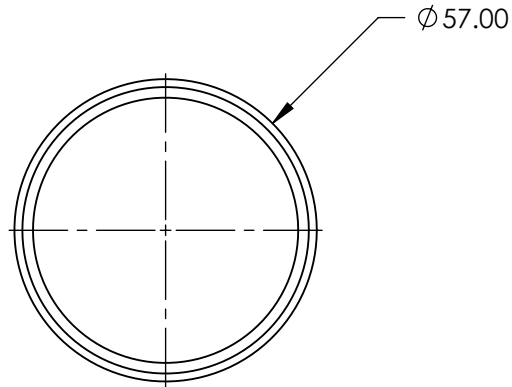
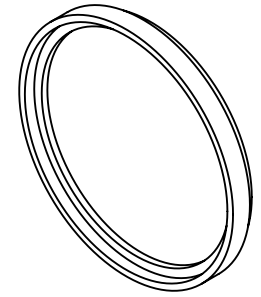
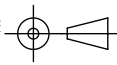

SPECIFICATIONS SUBJECT TO CHANGE WITHOUT NOTICE  
DIMENSIONS ARE FOR REFERENCE ONLY

REV. A	VALUE
SHAPE	PLANO
CUT-ON WAVELENGTH	390
SURFACE FLATNESS	4 - 6λ
SURFACE QUALITY	80-50
CLEAR APERTURE	Ø50

THIRD ANGLE PROJECTION 

ALL DIMS IN mm

 **Edmund Optics®**

TITLE M55 X 0.75 MOUNTED, UV CUT-OFF FILTER

DWG NO 54045

SHEET 1 OF 1