

NOTES:

1. SUBSTRATE
2. SURFACE S2 TO BE PARALLEL WITH SURFACE S1 TO WITHIN 5 arcsec
3.  FINE GRIND SURFACE
4. POWER, IRREGULARITY, AND SURFACE QUALITY SPECIFICATIONS APPLY ACROSS CLEAR APERTURE
5. ROHS COMPLIANT

**FOR INFORMATION ONLY:
DO NOT MANUFACTURE
PARTS TO THIS DRAWING**

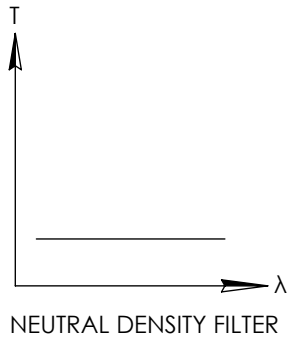
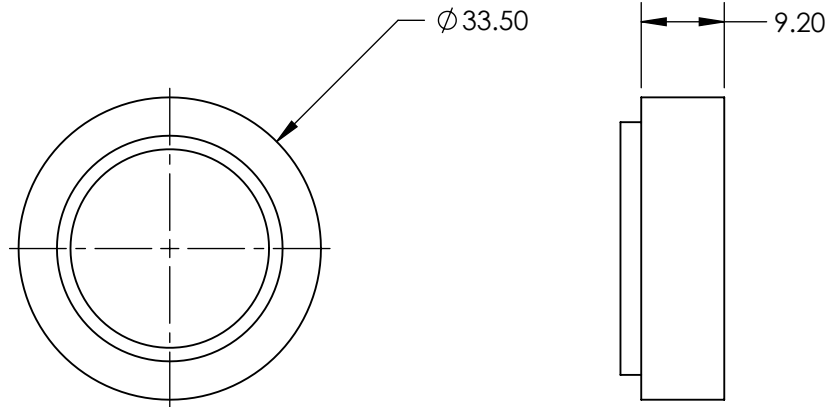
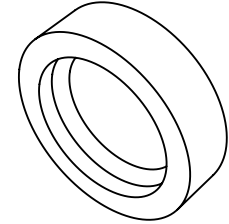

SPECIFICATIONS SUBJECT TO CHANGE WITHOUT NOTICE
DIMENSIONS ARE FOR REFERENCE ONLY

	S1	S2
SHAPE	PLANO	PLANO
CLEAR APERTURE	22	22
COATING APERTURE	UNCOATED	UNCOATED
BEVEL	PROTECTIVE AS NEEDED	PROTECTIVE AS NEEDED



ALL DIMS IN

mm

 **Edmund Optics®**

TITLE

M30.5 x 0.5, OD 2.5, 400 - 700nm ABSORPTIVE ND FILTER

DWG NO

66727

SHEET
1 OF 1