

**FOR INFORMATION ONLY:
DO NOT MANUFACTURE
PARTS TO THIS DRAWING**

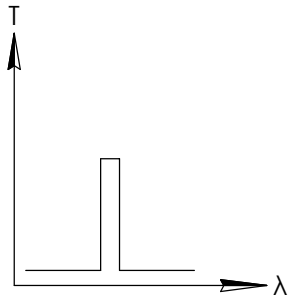
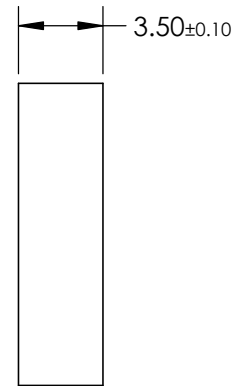
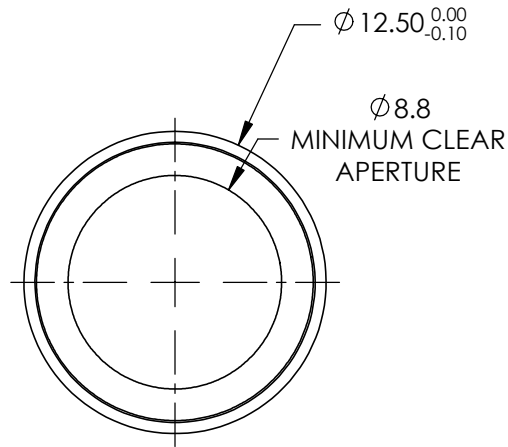
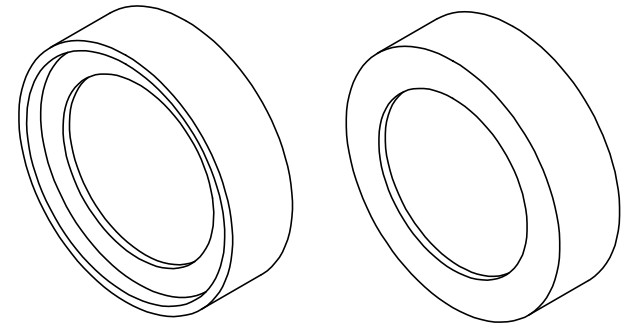

BANDPASS FILTER

REV. A	VALUE
CENTER WAVELENGTH (CWL)	482.5 ± 2nm
FULL WIDTH HALF MAX (FWHM)	36 ± 2nm
MINIMUM TRANSMISSION	93%
BLOCKING	250 - 1100nm
SURFACE QUALITY	60-40
CONSTRUCTION	MOUNTED IN BLACK ANODIZED ALUMINUM RING
COATING TYPE	HARD COATED
DURABILITY	MIL-C-48497A SECT. 3.4.1
ENVIRONMENTAL	MIL-STD-801F, SECT. 507.4

SPECIFICATIONS SUBJECT TO CHANGE WITHOUT NOTICE
DIMENSIONS ARE FOR REFERENCE ONLY



ALL DIMS IN

mm

TITLE

OD6, Ø12.5mm, 482.5nm x 36nm, BP
FLUORESCENCE FILTER

DWG NO

67014

SHEET
1 OF 1