

NOTES:

1. SUBSTRATE:
FUSED SILICA MOUNTED IN BLACK ANODIZED ALUMINUM RING
2. TRANSMITTED WAVEFRONT ERROR: $\lambda/4$
3. RoHS: COMPLIANT

**FOR INFORMATION ONLY:
DO NOT MANUFACTURE
PARTS TO THIS DRAWING**

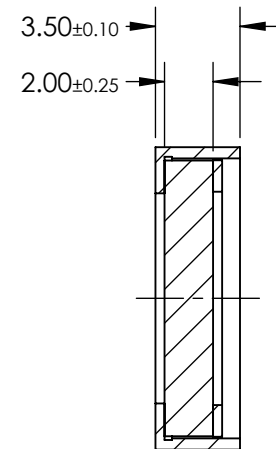
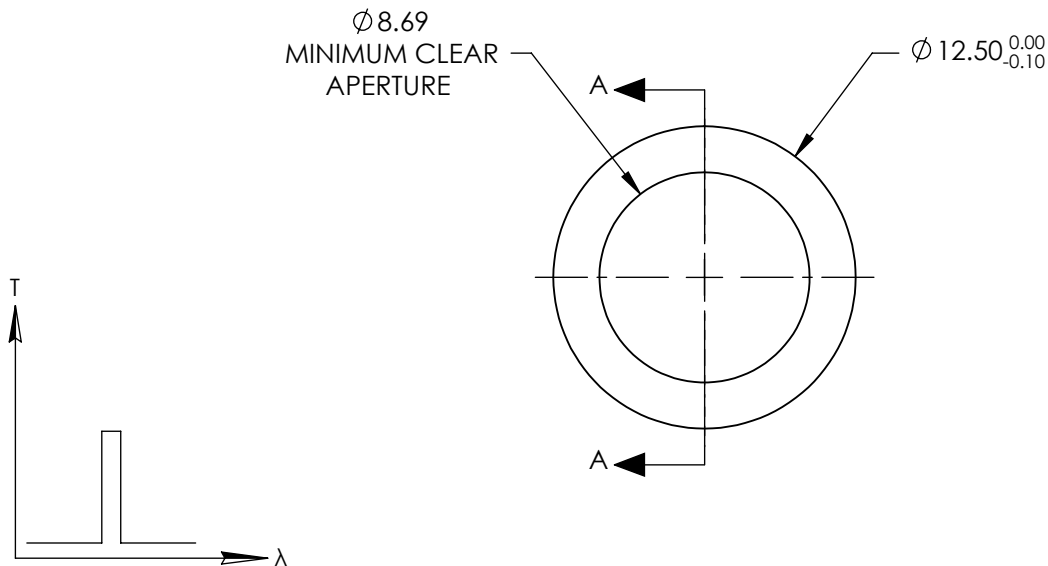

SECTION A-A

BANDPASS FILTER

	VALUE
CENTER WAVELENGTH (CWL) (nm)	697 ± 2
MINIMUM BANDPATH (nm)	75
FULL WIDTH HALF MAX (FWHM) (nm)	91
MINIMUM TRANSMISSION (%)	>93
OD6 BLOCKING RANGE (nm)	470 - 632 & 800 - 900
SURFACE QUALITY	60-40
COATING TYPE	HARD COATED
DURABILITY	MIL-C-48497A, SECT. 3.4.1
ENVIRONMENTAL	MIL-STD-801F, SECT. 507 .4

SPECIFICATIONS SUBJECT TO CHANGE WITHOUT NOTICE
DIMENSIONS ARE FOR REFERENCE ONLY

EO® **Edmund Optics**®

THIRD ANGLE PROJECTION

TITLE OD6, Ø12.5mm, 697nm x 75nm, BP
FLUORESCENCE FILTER

ALL DIMS IN mm

DWG NO 87743

SHEET
1 OF 1