

DETAIL B

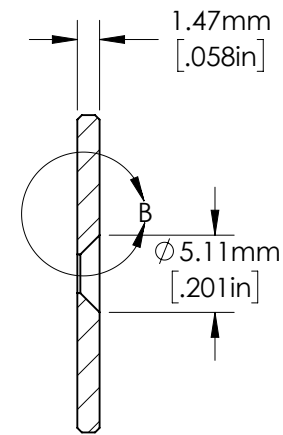
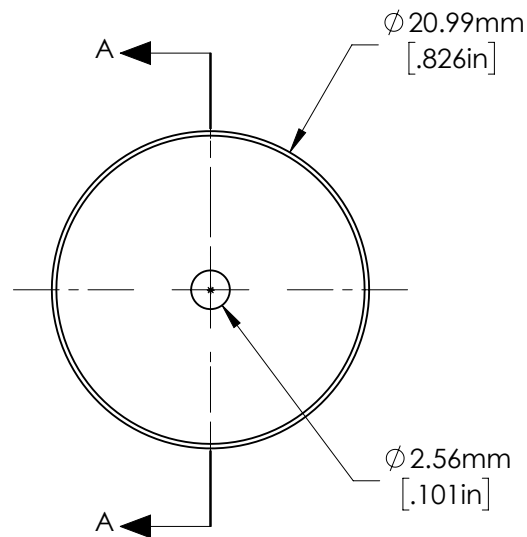

SECTION A-A

SPECIFICATIONS SUBJECT TO CHANGE WITHOUT NOTICE
DIMENSIONS ARE FOR REFERENCE ONLY

FOR INFORMATION ONLY:
DO NOT MANUFACTURE
PARTS TO THIS DRAWING

 **Edmund Optics®**

TITLE	F5.6 APERTURE FOR 25mm Cx LENS	
DWG NO	33656	SHEET 1 OF 1