

**FOR INFORMATION ONLY:
DO NOT MANUFACTURE
PARTS TO THIS DRAWING**

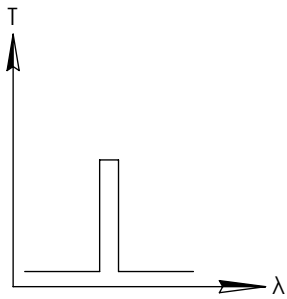
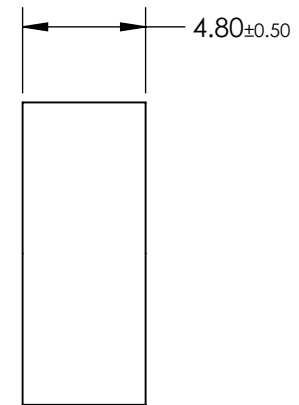
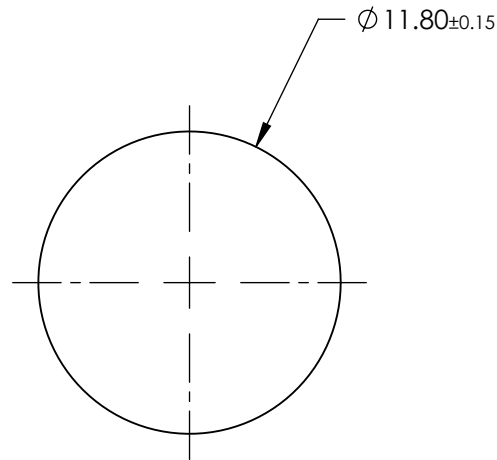
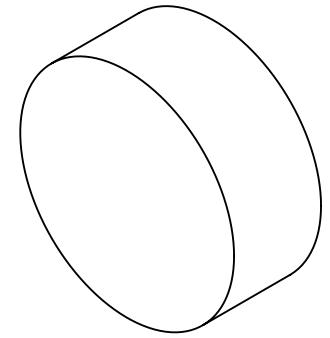

BANDPASS FILTER

SPECIFICATIONS SUBJECT TO CHANGE WITHOUT NOTICE
DIMENSIONS ARE FOR REFERENCE ONLY

	S1	S2
SHAPE	PLANO	PLANO
SURFACE QUALITY	80-50	80-50
CLEAR APERTURE	>9.2	>9.2
FULL WIDTH HALF MAX (FWHM)	10nm	10nm
BEVEL	PROTECTED AS NEEDED	PROTECTED AS NEEDED

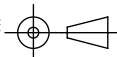
THIRD ANGLE PROJECTION 

ALL DIMS IN mm

EO® **Edmund Optics**®

TITLE: $\varnothing 11.8\text{mm}$, 394 x 10 UNMOUNTED BANDPASS FILTER

DWG NO: 46033

SHEET 1 OF 1