

NOTES:

1. SUBSTRATE MATERIAL: N-BK7
2. ONLY ROHS-COMPLIANT MATERIALS ARE ACCEPTABLE.  
DO NOT SUBSTITUTE WITH ROHS EXEMPT OR NON-COMPLIANT MATERIALS
3. COATING (APPLY ACROSS CLEAR APERTURE)  
S1 & S2 : VIS-NIR  
Rabs ≤ 0.25% @ 880nm
4. FINE GRIND SURFACE
5. POWER, IRREGULARITY, AND SURFACE QUALITY SPECIFICATIONS APPLY ACROSS CLEAR APERTURE
6. CHIPS OUTSIDE OF CLEAR APERTURE: <0.5
7. CLEAR APERTURE AND COATING APERTURE ARE CENTERED ON SURFACES

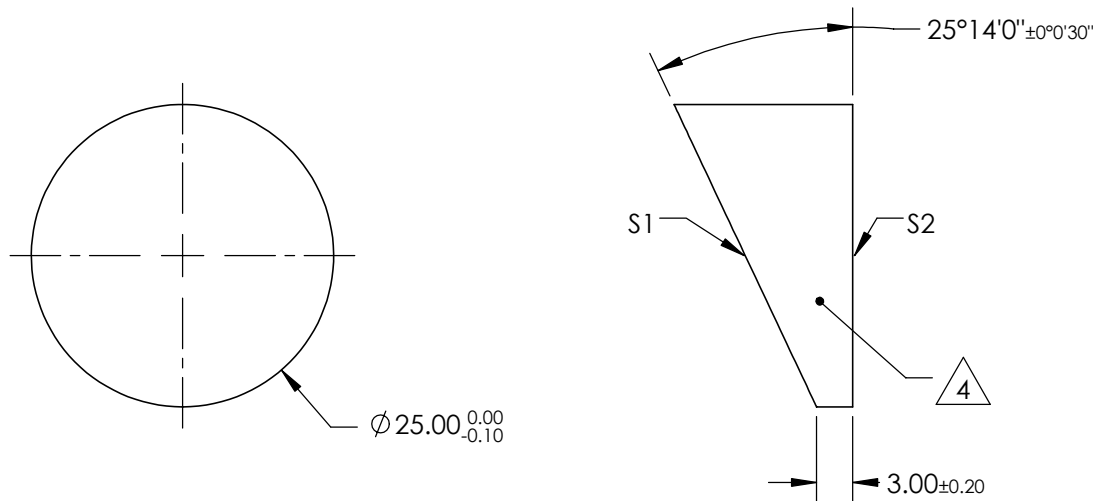

**FOR INFORMATION ONLY:  
DO NOT MANUFACTURE  
PARTS TO THIS DRAWING**

REV. A	S1 & S2
SHAPE	PLANO
POWER (DIOPTERS)	26.79
ANGLE TOL. (ARCSEC)	±30
SURFACE QUALITY	60-40
SURFACE FLATNESS	λ/4
WAVELENGTH RANGE (nm)	400 - 1000
CLEAR APERTURE	Ø22.50
IMAGE ORIENTATION	BEAM DEVIATION
BEVEL	PROTECTIVE AS NEEDED

SPECIFICATIONS SUBJECT TO CHANGE WITHOUT NOTICE  
DIMENSIONS ARE FOR REFERENCE ONLY



ALL DIMS IN

mm

TITLE

15° NOM. VIS-NIR COATED, WEDGE PRISM

DWG NO

47624

SHEET  
1 OF 1