

**FOR INFORMATION ONLY:
DO NOT MANUFACTURE
PARTS TO THIS DRAWING**

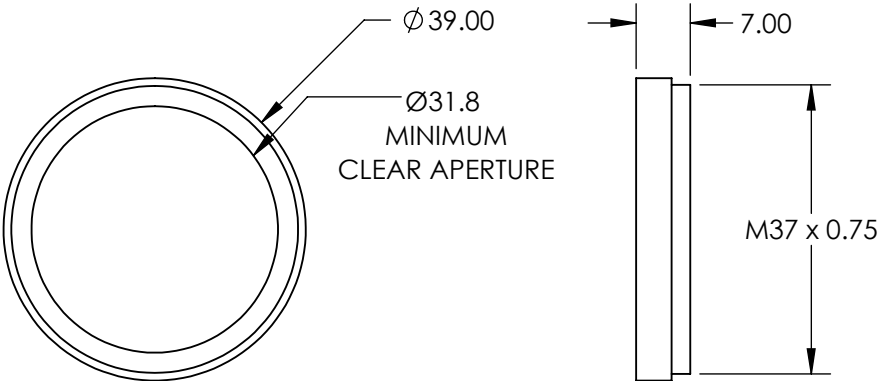

SPECIFICATIONS SUBJECT TO CHANGE WITHOUT NOTICE
DIMENSIONS ARE FOR REFERENCE ONLY

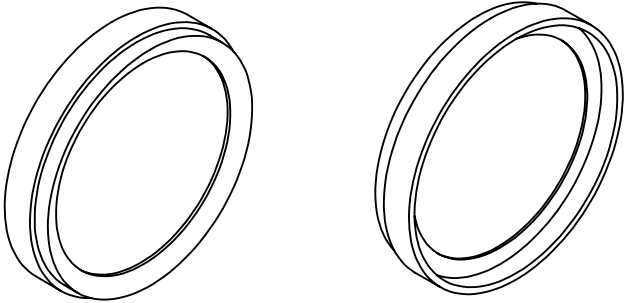

REV. A	VALUE
CUT-ON WAVELENGTH	N/A
CUT-OFF WAVELENGTH	<750nm
SURFACE QUALITY	60-40

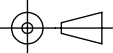
THIRD ANGLE PROJECTION 

ALL DIMS IN mm

TITLE	M37 X 0.75 MOUNTED IR CUT-OFF FILTER
DWG NO	49802
SHEET 1 OF 1	