

**FOR INFORMATION ONLY:  
DO NOT MANUFACTURE  
PARTS TO THIS DRAWING**

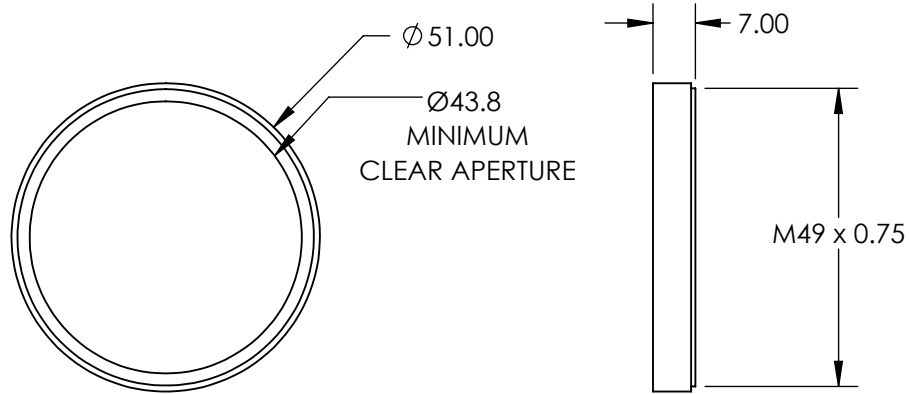

SPECIFICATIONS SUBJECT TO CHANGE WITHOUT NOTICE  
DIMENSIONS ARE FOR REFERENCE ONLY

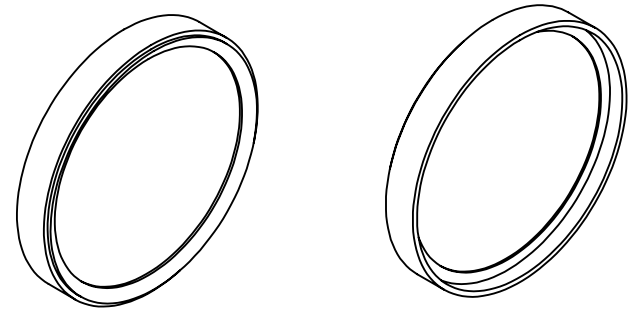

REV. A	VALUE
CUT-ON WAVELENGTH	N/A
CUT-OFF WAVELENGTH	<750nm
SURFACE QUALITY	60-40

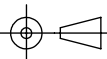
THIRD ANGLE PROJECTION 

ALL DIMS IN mm

TITLE	M49 X 0.75 MOUNTED IR CUT-OFF FILTER
DWG NO	54745
SHEET	1 OF 1