

NOTES:

1. SUBSTRATE MATERIAL: BOROFLOAT®/SUPREMAX®

**FOR INFORMATION ONLY:
DO NOT MANUFACTURE
PARTS TO THIS DRAWING**

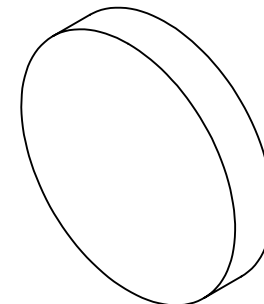

2. PARABOLIC SURFACE:

$$Z=Y^2/[4 * EFL]$$

3. COATING (APPLY ACROSS CLEAR APERTURE)

S1: R(avg) >95% @ 450 - 650nm

S2: NONE

4. EDGES: MOLDED EDGE ACCEPTABLE

5. POWER, IRREGULARITY, SURFACE QUALITY AND COATING SPECIFICATIONS APPLY ACROSS CLEAR APERTURE

6. FINE GRIND SURFACE

7. RoHS COMPLIANT

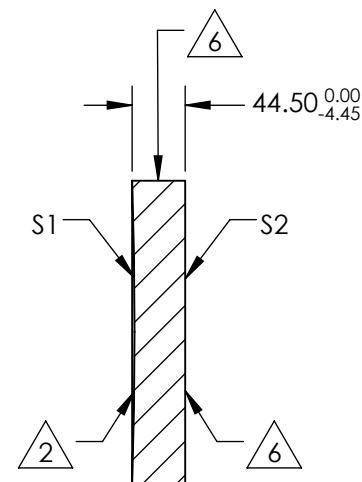
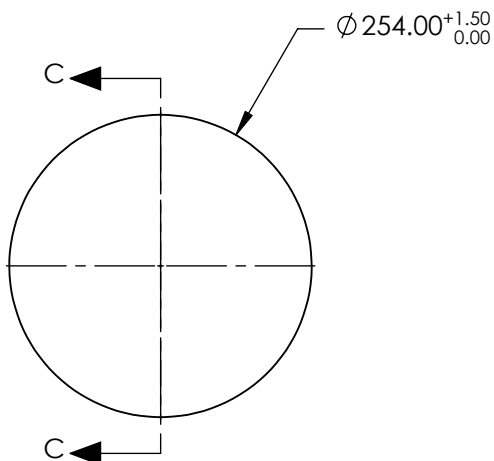

SECTION C-C

SPECIFICATIONS SUBJECT TO CHANGE WITHOUT NOTICE
DIMENSIONS ARE FOR REFERENCE ONLY

REV. A	S1	S2
SHAPE	CONCAVE	PLANO
EFFECTIVE FOCAL LENGTH	2032nm	N/A
FOCAL LENGTH TOLERANCE	±1.5%	N/A
SURFACE QUALITY	60-40	FINE GRIND
SURFACE FLATNESS	λ/8	N/A
BEVEL	PROTECTIVE AS NEEDED	PROTECTIVE AS NEEDED

THIRD ANGLE PROJECTION

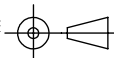

ALL DIMS IN

mm

EO® Edmund Optics®

TITLE 10" Diameter x 80" FL Enhanced Aluminum, Parabolic Mirror

DWG NO

32275533

SHEET 1 OF 1