

NOTES:

- 1. ELEMENT A: 45806
- 2. ELEMENT B: 45806

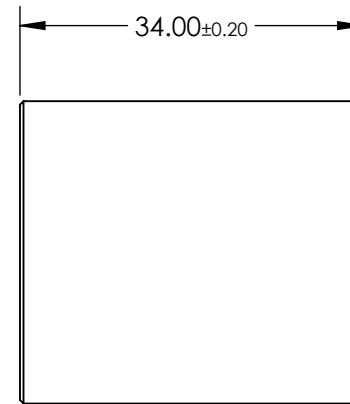
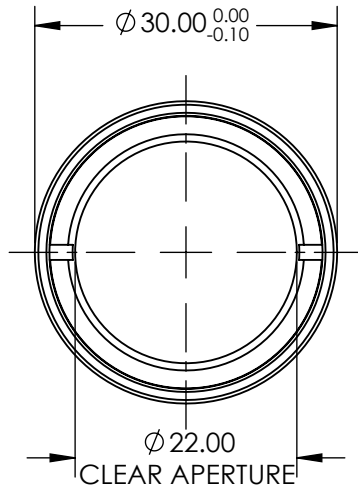
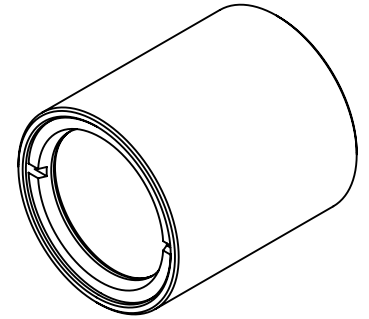

SPECIFICATIONS SUBJECT TO CHANGE WITHOUT NOTICE
DIMENSIONS ARE FOR REFERENCE ONLY

**FOR INFORMATION ONLY:
DO NOT MANUFACTURE
PARTS TO THIS DRAWING**

 **Edmund Optics®**

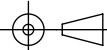
THIRD ANGLE PROJECTION 		TITLE	1:1 WITH 100mm AND 100mm EFL ACHROMATS, NIR ACHROMATIC PAIR	
ALL DIMS IN	mm	DWG NO	47302	SHEET 1 OF 1