

NOTES:

1. SUBSTRATE MATERIAL: Fused Silica
2. SURFACE S2 TO BE PARALLEL WITH S1 TO 30 arcsec
3. COATING (APPLY ACROSS CLEAR APERTURE)

S1: Protected Silver
 R(avg) >98% @ 450 - 2000nm
 R(avg) >98% @ 2000 - 10,000nm
 S2: NONE

 FINE GRIND SURFACE

5. RoHS COMPLIANT

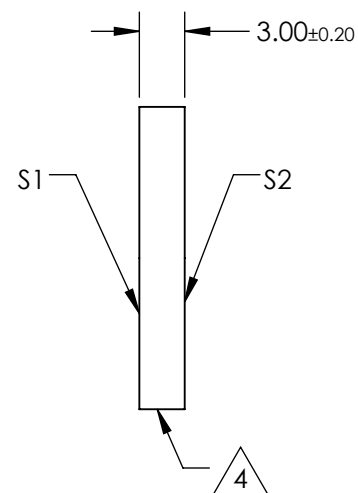
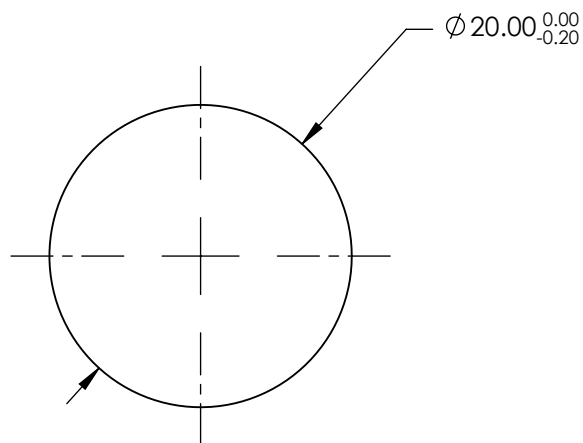
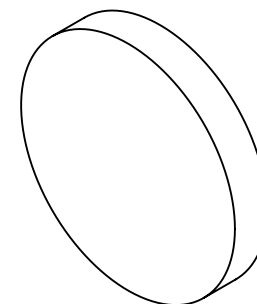

**FOR INFORMATION ONLY:
 DO NOT MANUFACTURE
 PARTS TO THIS DRAWING**

SPECIFICATIONS SUBJECT TO CHANGE WITHOUT NOTICE
 DIMENSIONS ARE FOR REFERENCE ONLY

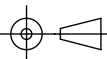

REV. A	S1	S2	THIRD ANGLE PROJECTION 		TITLE	20mm Diameter Protected Silver Coated, λ/10 Mirror	
SURFACE QUALITY	20-10	COMMERCIAL POLISH	ALL DIMS IN	mm	DWG NO	68327	SHEET 1 OF 1
SURFACE FLATNESS	λ/10	NA					
BEVEL	PROTECTIVE AS NEEDED	PROTECTIVE AS NEEDED					