

NOTES:

- 1. SUBSTRATE MATERIAL:
FLOAT GLASS
- 2. COATING (APPLY ACROSS CLEAR APERTURE)

S1: R(avg) >85% @ 400 - 700nm

S2: NONE
- 3. ROHS COMPLIANT

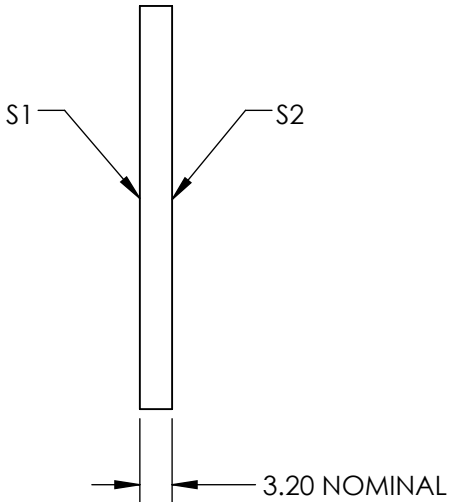
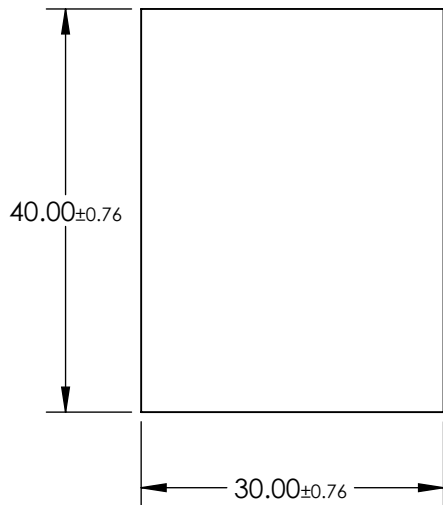
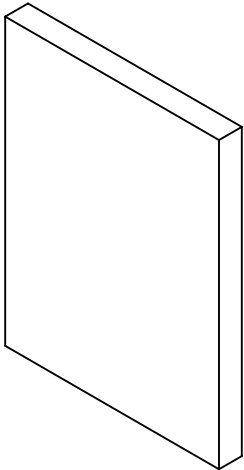

**FOR INFORMATION ONLY:
DO NOT MANUFACTURE
PARTS TO THIS DRAWING**

SPECIFICATIONS SUBJECT TO CHANGE WITHOUT NOTICE
DIMENSIONS ARE FOR REFERENCE ONLY

REV. A	S1	S2
SHAPE	PLANO	PLANO
ANGLE OF INCIDENCE	45°	N/A
SURFACE QUALITY	80-50	80-50
SURFACE FLATNESS	4 - 6λ	4 - 6λ
BEVEL	PROTECTIVE AS NEEDED	PROTECTIVE AS NEEDED

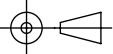
THIRD ANGLE PROJECTION 

ALL DIMS IN mm

 **Edmund Optics®**

TITLE: 30 x 40mm, 4-6λ Mirror

DWG NO: 30429

SHEET 1 OF 1