

NOTES:

1. SUBSTRATE:  
FLOAT GLASS

2. FINE GROUND SURFACE

3. RoHS COMPLIANT

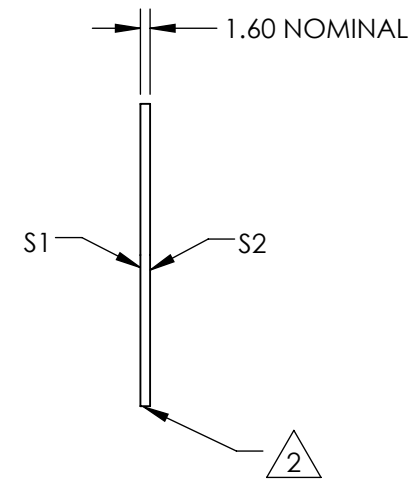
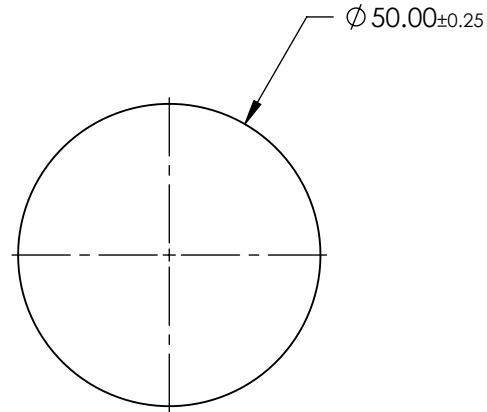
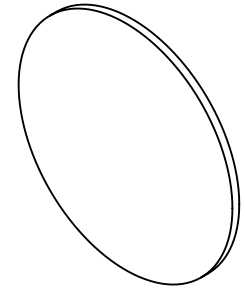

**FOR INFORMATION ONLY:  
DO NOT MANUFACTURE  
PARTS TO THIS DRAWING**

SPECIFICATIONS SUBJECT TO CHANGE WITHOUT NOTICE  
DIMENSIONS ARE FOR REFERENCE ONLY

**EO**® Edmund Optics®

	S1	S2	THIRD ANGLE PROJECTION		TITLE	50mm DIAMETER 120 GRIT GROUND GLASS DIFFUSER	
SHAPE	PLANO	PLANO	ALL DIMS IN	mm	DWG NO	83420	SHEET 1 OF 1
WAVELENGTH RANGE	350 - 2000nm	350 - 2000nm					
BEVEL	PROTECTIVE AS NEEDED	PROTECTIVE AS NEEDED					