

NOTES:

1. ELEMENT A: 32315
2. ELEMENT B: 45137

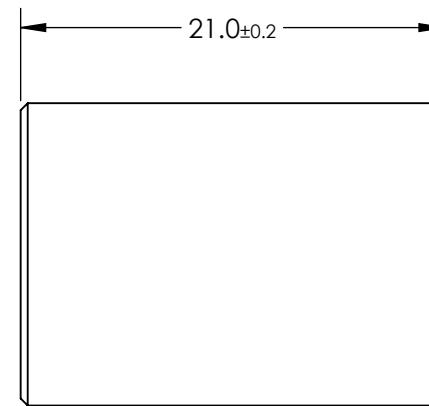
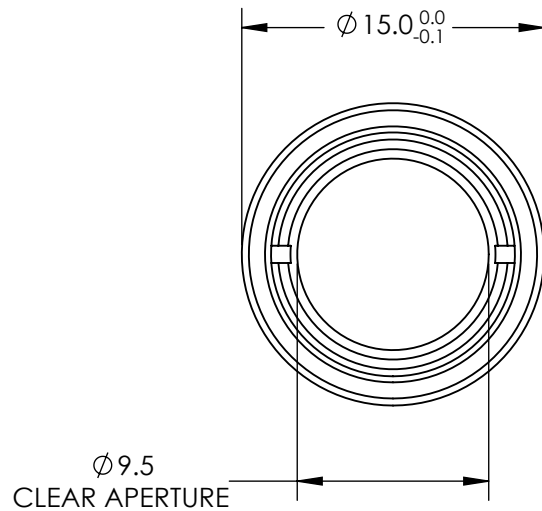
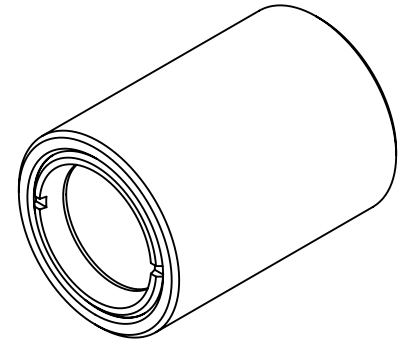

SPECIFICATIONS SUBJECT TO CHANGE WITHOUT NOTICE
 DIMENSIONS ARE FOR REFERENCE ONLY

**FOR INFORMATION ONLY:
 DO NOT MANUFACTURE
 PARTS TO THIS DRAWING**

EO® Edmund Optics®

THIRD ANGLE PROJECTION		TITLE	1:1.5 WITH 40mm AND 60mm EFL ACHROMATS, 15mm ACHROMATIC PAIR	
ALL DIMS IN	mm	DWG NO	46001	SHEET 1 OF 1