

NOTES:

1. SUBSTRATE:
GRADE A FINE ANNEALED
SCHOTT: N-LaSF9 850/322
2. ROHS COMPLIANT
3. CENTERING TOLERANCE (AT 587.6nm):
BEAM DEVIATION (HALF ANGLE): <45 ARCMIN
4. COATING (APPLY ACROSS COATING APERTURE)
S1 & S2: VIS-EXT
R(AVG) ≤ 0.5% FROM 350-700nm @ 0° AOI
5. FINE GRIND SURFACE
6. POWER, IRREGULARITY, AND SURFACE QUALITY SPECIFICATIONS APPLY ACROSS CLEAR APERTURE
7. FOCAL LENGTH (EFL): 1.50mm ±1%
BACK FOCAL LENGTH (BFL): 1.07mm
8. PROTECTIVE BEVEL AS NEEDED
9. DESIGN WAVELENGTH: 587.6nm

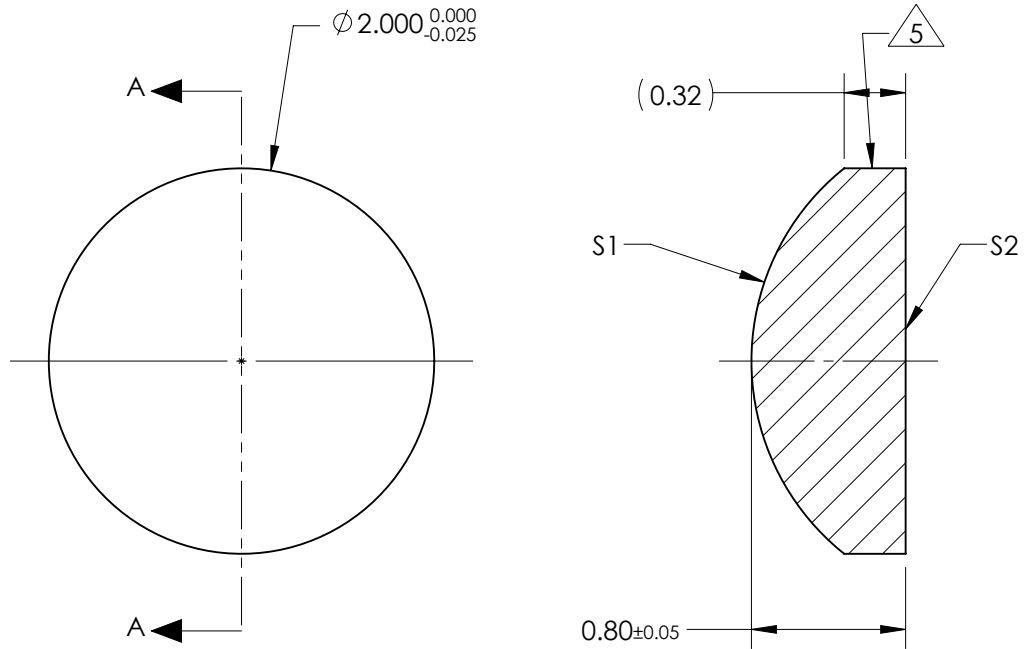

SECTION A-A

**FOR INFORMATION ONLY:
DO NOT MANUFACTURE
PARTS TO THIS DRAWING**

	S1	S2
SHAPE	CONVEX	PLANO
RADIUS	1.28	INFINITY
SURFACE QUALITY	20 - 10	20 - 10
MIN CLEAR APERTURE	$\phi 1.50$	$\phi 1.50$
MIN COATING APERTURE	$\phi 1.50$	$\phi 1.50$
POWER AT 632.8nm	3.00 RINGS	3.00 RINGS
IRREGULARITY AT 632.8nm	0.50 RINGS	0.50 RINGS

SPECIFICATIONS SUBJECT TO CHANGE WITHOUT NOTICE
DIMENSIONS ARE FOR REFERENCE ONLY

EO® Edmund Optics®

THIRD ANGLE PROJECTION		TITLE	2mm Dia x 1.5mm FL, VIS-EXT Coated, Plano-Convex Lens
ALL DIMS IN	mm	DWG NO	35701
			SHEET 1 OF 1