

NOTES:

1. SUBSTRATE:  
CRYSTAL QUARTZ
2. COATING (APPLY ACROSS CLEAR APERTURE)  
S1 & S2: R(ABS) <0.25% @ 532nm  
DAMAGE THRESHOLD: 3.5 J/cm<sup>2</sup> @10ns @ 1064nm
3. SURFACE S1 TO BE PARALLEL TO SURFACE S2 TO WITHIN <0.5 arcsec
4. RETARDANCE:  $\lambda/4 \pm \lambda/200$
5. TRANSMITTED WAVEFRONT:  $\lambda/10$
6. RoHS COMPLIANT

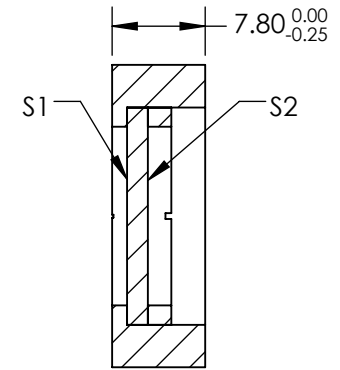
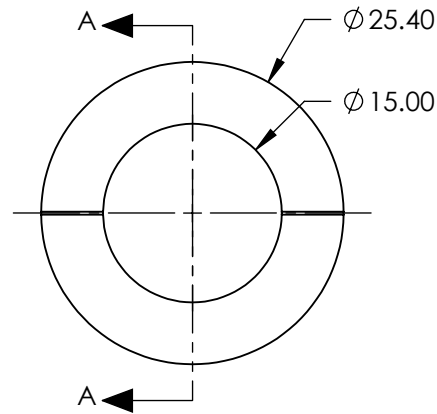

SECTION A-A

**FOR INFORMATION ONLY:  
DO NOT MANUFACTURE  
PARTS TO THIS DRAWING**

SPECIFICATIONS SUBJECT TO CHANGE WITHOUT NOTICE  
DIMENSIONS ARE FOR REFERENCE ONLY

**EO**® Edmund Optics®

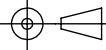
	S1	S2	THIRD ANGLE PROJECTION 	TITLE	Ø25.4mm, 532nm, $\lambda/4$ QUARTZ WAVEPLATE ZERO ORDER	
CLEAR APERTURE	Ø15.0	Ø15.0		ALL DIMS IN	mm	DWG NO
SURFACE QUALITY	10-5	10-5				SHEET 1 OF 1