

**FOR INFORMATION ONLY:  
DO NOT MANUFACTURE  
PARTS TO THIS DRAWING**

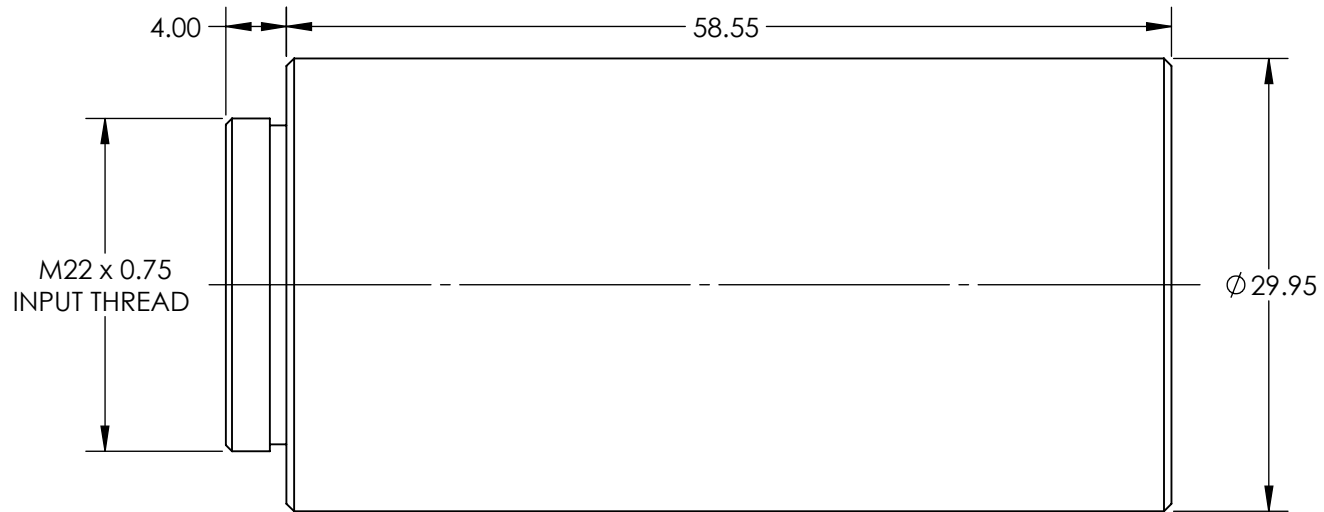

SPECIFICATIONS SUBJECT TO CHANGE WITHOUT NOTICE  
DIMENSIONS ARE FOR REFERENCE ONLY

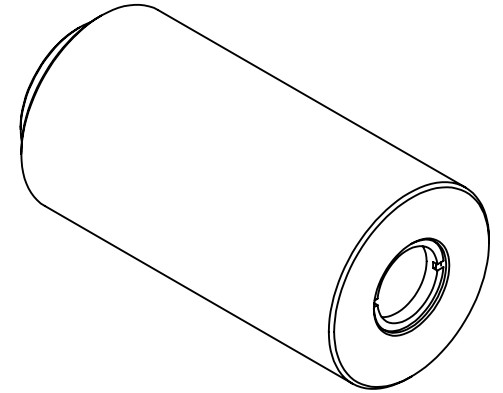

EXPANSION POWER	4X
DESIGN WAVELENGTH DWL (nm)	532
INPUT APERTURE DIAMETER(mm)	5.0
EXIT APERTURE DIAMETER(mm)	10.0



ALL DIMS IN

mm

TITLE	4X, 532nm Scorpii™ Nd:YAG Beam Expander
DWG NO	37053
SHEET	1 OF 1