

NOTES:

- 1. MATERIAL: COPPER
- 2. RoHS: COMPLIANT

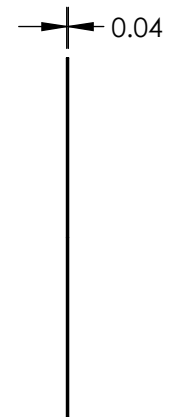
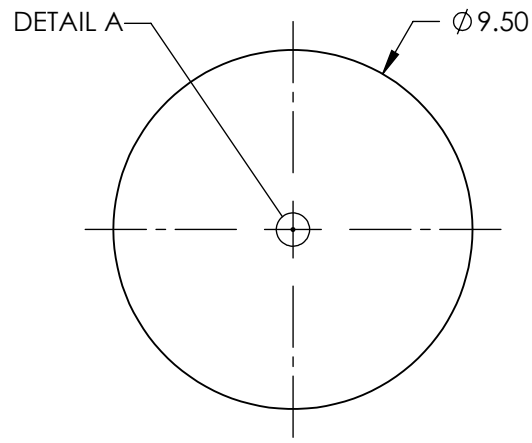
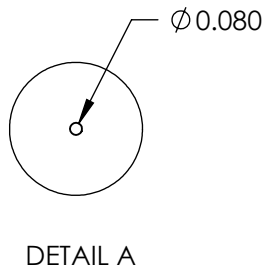
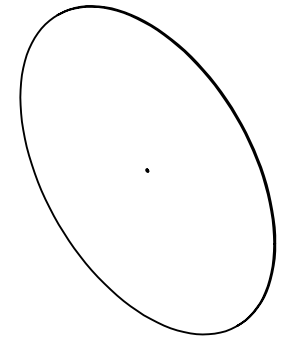

SPECIFICATIONS SUBJECT TO CHANGE WITHOUT NOTICE  
DIMENSIONS ARE FOR REFERENCE ONLY

**FOR INFORMATION ONLY:  
DO NOT MANUFACTURE  
PARTS TO THIS DRAWING**

**EO**® Edmund Optics®

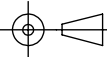
THIRD ANGLE PROJECTION 		TITLE	80µm APERTURE DIAMETER, COPPER APERTURE	
ALL DIMS IN	mm	DWG NO	39891	SHEET 1 OF 1