

**FOR INFORMATION ONLY:
DO NOT MANUFACTURE
PARTS TO THIS DRAWING**

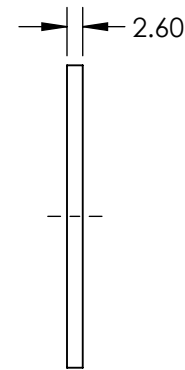
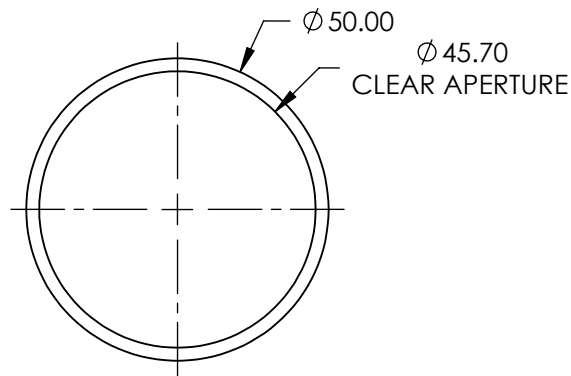
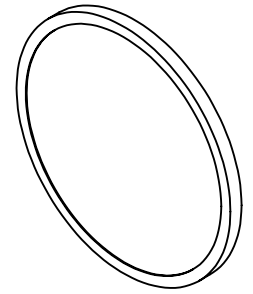

ANGLE TOLERANCE (°)	±2
DIFFUSING ANGLE (°)	20 (FWHM)
DAMAGE THRESHOLD, PULSED	0.22 J/cm ² @ 1064nm @ 10ns
OPERATING TEMPERATURE (°C)	-30 to +100 (Maximum of 240 Hours)
SUBSTRATE	Polycarbonate
TRANSMISSION (%)	>85
WAVELENGTH RANGE (nm)	400 - 1600
RoHS	COMPLIANT

SPECIFICATIONS SUBJECT TO CHANGE WITHOUT NOTICE
DIMENSIONS ARE FOR REFERENCE ONLY

EO® **Edmund Optics**®



TITLE	20° Diffusing Angle 50mm Dia Mounted		
DWG NO	54497	SHEET	1 OF 1

ALL DIMS IN

mm