

NOTES:

1. CONSTRUCTION:
Brass Housing, Blue Tempered Steel Leaves
2. NUMBER OF LEAVES: 8
3. ROHS: COMPLIANT

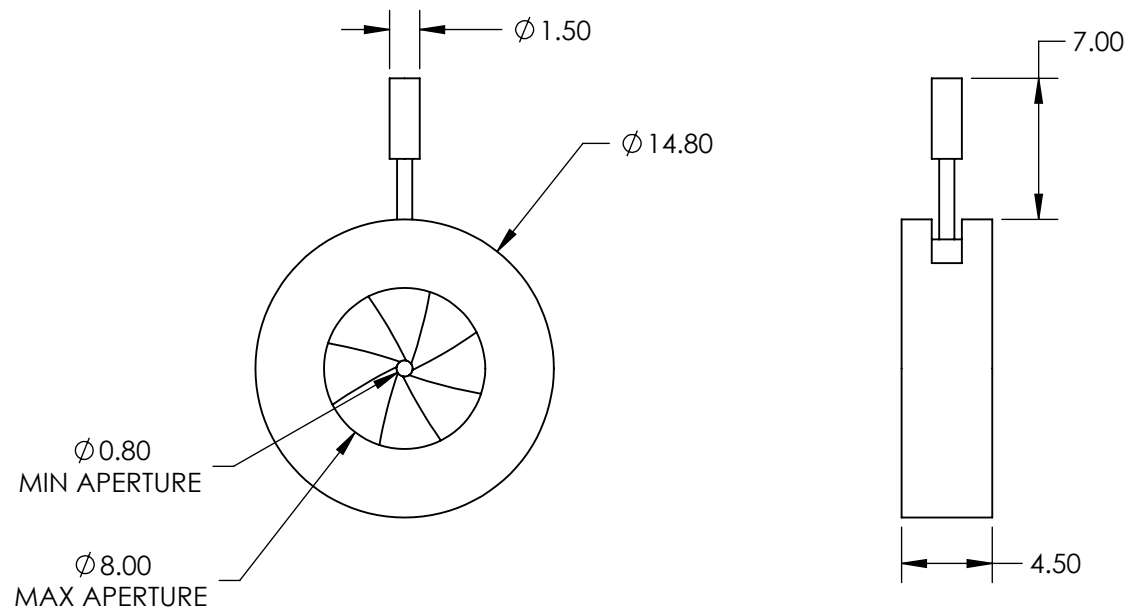

SPECIFICATIONS SUBJECT TO CHANGE WITHOUT NOTICE
DIMENSIONS ARE FOR REFERENCE ONLY

**FOR INFORMATION ONLY:
DO NOT MANUFACTURE
PARTS TO THIS DRAWING**

EO® Edmund Optics®

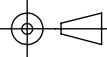
THIRD ANGLE PROJECTION 		TITLE	IRIS DIAPHRAGM 14.8mm DIA.	
ALL DIMS IN	mm	DWG NO	32623	SHEET 1 OF 1