

NOTES:

1. SUBSTRATE:
Alumoscilate Glass Embedded with Silver Ions
2. COATING (APPLY ACROSS COATING APERTURE)
S1 & S2: BBAR (1310-1550nm)
R(AVG) < 0.5% @ 1310 - 1550nm ±30nm
3. EFL: 0.46
4. f/# : 0.92
5. NUMERICAL APERTURE: 0.55
6. DESIGN WAVELENGTH: 1550nm
7. WORKING DISTANCE: 0mm
8. ROHS: COMPLIANT

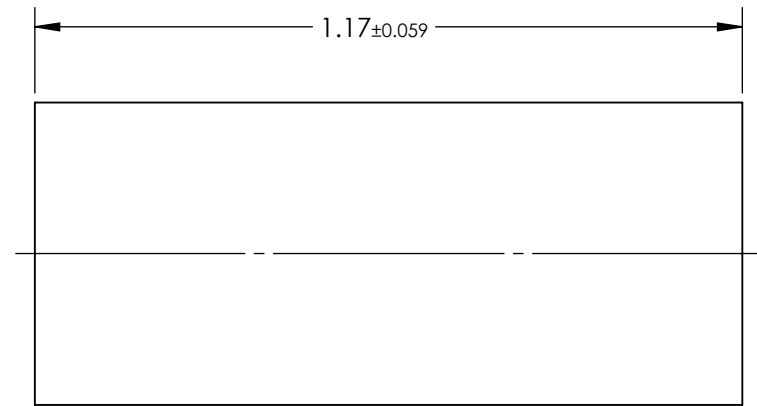
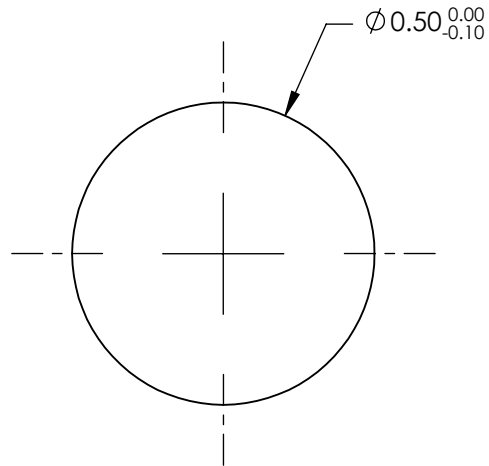

**FOR INFORMATION ONLY:
DO NOT MANUFACTURE
PARTS TO THIS DRAWING**

SPECIFICATIONS SUBJECT TO CHANGE WITHOUT NOTICE
DIMENSIONS ARE FOR REFERENCE ONLY



	S1	S2	THIRD ANGLE PROJECTION		TITLE	0.5mm Dia, 1550nm DWL, 0.0mm WD, NIR Coated, GRIN Lens	
SHAPE	PLANO	PLANO	ALL DIMS IN	mm	DWG NO	64545	SHEET 1 OF 1
SURFACE QUALITY	40-20	40-20					
CLEAR APERTURE	Ø0.45	Ø0.45					