

NOTES:

1. SUBSTRATE:
Crystal Quartz and MgF2
2. COATING (APPLY ACROSS COATING APERTURE):
S1 & S2: R(AVG) <0.75% @ 550 - 750nm

DAMAGE THRESHOLD,
PULSED: >5 J/cm², 10ns @ 10Hz @ 1064nm
3. SURFACE S1 TO BE PARALLEL TO SURFACE S2 TO WITHIN <10 ARCSEC
4. RETARDANCE: $\lambda/4 \pm \lambda/100$ @ 20°C
5. DESIGN WAVELENGTH: 550 - 750 nm
6. TRANSMITTED WAVEFRONT: < $\lambda/4$ @ 632nm
7. CONSTRUCTION: Crystalline
8. ROHS: COMPLIANT

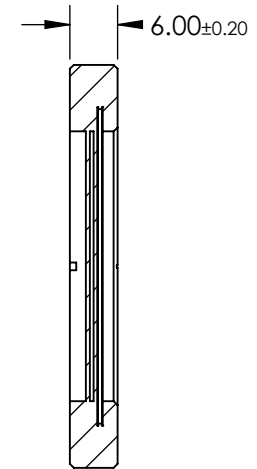
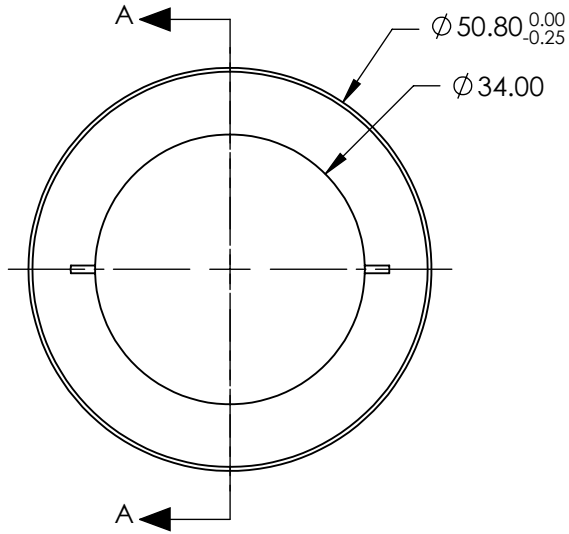

SECTION A-A

**FOR INFORMATION ONLY:
DO NOT MANUFACTURE
PARTS TO THIS DRAWING**

SPECIFICATIONS SUBJECT TO CHANGE WITHOUT NOTICE
DIMENSIONS ARE FOR REFERENCE ONLY

EO® Edmund Optics®

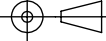
	S1	S2	THIRD ANGLE PROJECTION 	TITLE	50.8mm Dia, 550 - 750nm, $\lambda/4$ Achromatic Waveplate	
SURFACE QUALITY	40-20	40-20	ALL DIMS IN	mm	DWG NO	39040
CLEAR APERTURE	> Ø34	> Ø34				SHEET 1 OF 1