

NOTES:

1. CONSTRUCTION:
Anodized Aluminum Alloy, Stainless Steel Leaves
2. NUMBER OF LEAVES: Two sets of 7
3. OPERATING TEMPERATURE (°C): <400
4. ROHS: COMPLIANT

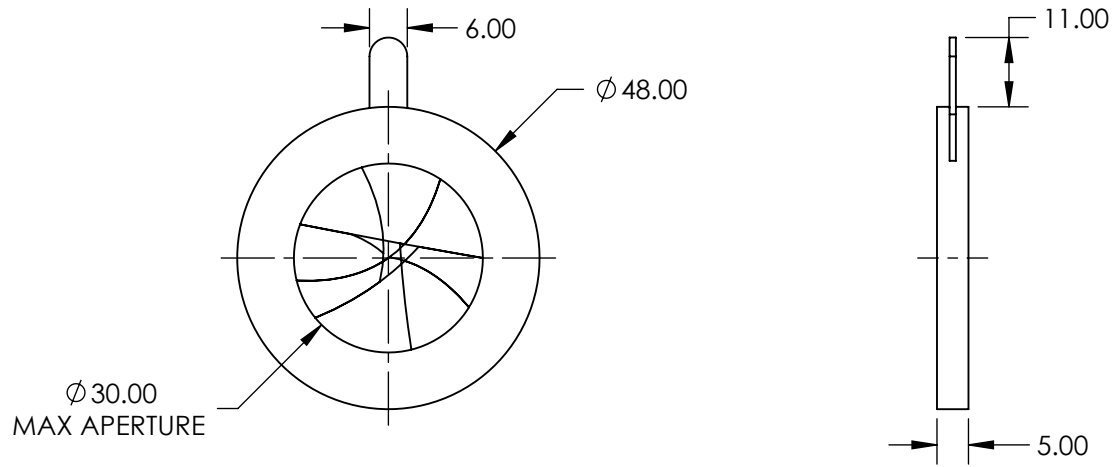

SPECIFICATIONS SUBJECT TO CHANGE WITHOUT NOTICE
DIMENSIONS ARE FOR REFERENCE ONLY

**FOR INFORMATION ONLY:
DO NOT MANUFACTURE
PARTS TO THIS DRAWING**

EO® Edmund Optics®

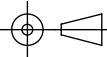
THIRD ANGLE PROJECTION 		TITLE	48mm Outer Dia., Zero Aperture, Stainless Steel Leaves	
ALL DIMS IN	mm	DWG NO	57597	SHEET 1 OF 1