

FOCAL LENGTH (EFL): 175 ±1,75
 BACK FOCAL LENGTH (BFL): 170,84

SURFACE A	SURFACE B	SURFACE C
Øe 24	Øe 24	Øe 24
CEMENT: NOA 61 OR EQUIVALENT		

PROTECTIVE CHAMFERS AS NEEDED		FIRST ANGLE PROJECTION	 Edmund Optics®						
ROHS: COMPLIANT	SCALE: NONE $\lambda = 587,6\text{nm}$								
SPECIFICATIONS SUBJECT TO CHANGE WITHOUT NOTICE. DIMENSIONS ARE FOR REFERENCE ONLY			TITLE	25mm Dia, x 175mm FL, MgF2 Coated, Achromatic Doublet Lens					
FOR INFORMATION ONLY: DO NOT MANUFACTURE PARTS TO THIS DRAWING			ALL DIMS IN:	mm	DWG NO	32884	SHEET SIZE	A4	SHEET
INDICATIONS IN ACCORDANCE WITH ISO 10110									

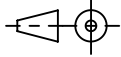
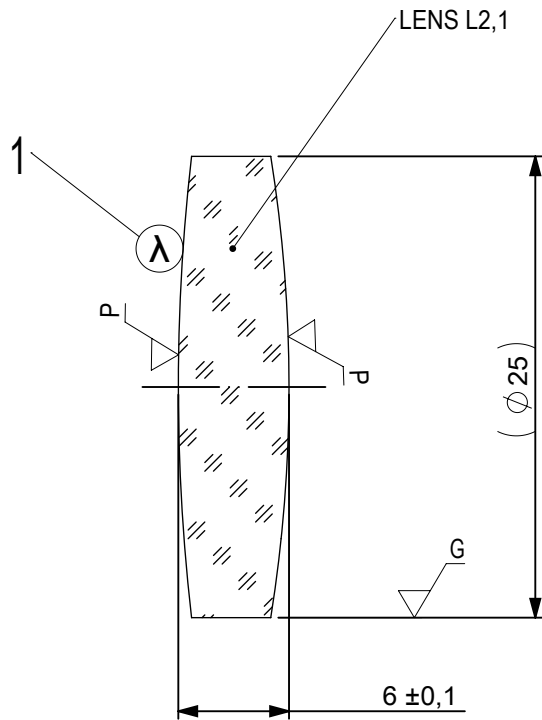

1 AR COATING:

¼ WAVE MgF2 @ 550nm
 R(AVG) < 1,75% FROM 400-700nm (N-BK7)

LEFT SURFACE	MATERIAL	RIGHT SURFACE
R 109,16±0,109 CX Øe 24 3/ 3 (0,5) λ=632,8 nm 4/ - 5/ 40 - 20 (MIL-PRF-13830B) 6/ -	GLASS N-BK7 517/642	R 79,38±0,079 CX Øe 24 3/ 3 (0,5) λ=632,8 nm 4/ - 5/ 40 - 20 (MIL-PRF-13830B) 6/ -

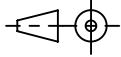
PROTECTIVE CHAMFERS AS NEEDED		FIRST ANGLE PROJECTION	 Edmund Optics®			
ROHS: COMPLIANT	SCALE: NONE λ = 587,6nm					
SPECIFICATIONS SUBJECT TO CHANGE WITHOUT NOTICE. DIMENSIONS ARE FOR REFERENCE ONLY			TITLE	25mm Dia, x 175mm FL, MgF2 Coated, Achromatic Doublet Lens		
FOR INFORMATION ONLY: DO NOT MANUFACTURE PARTS TO THIS DRAWING			ALL DIMS IN:	mm	DWG NO	
INDICATIONS IN ACCORDANCE WITH ISO 10110				32884	SHEET SIZE A4	SHEET 2 OF 3

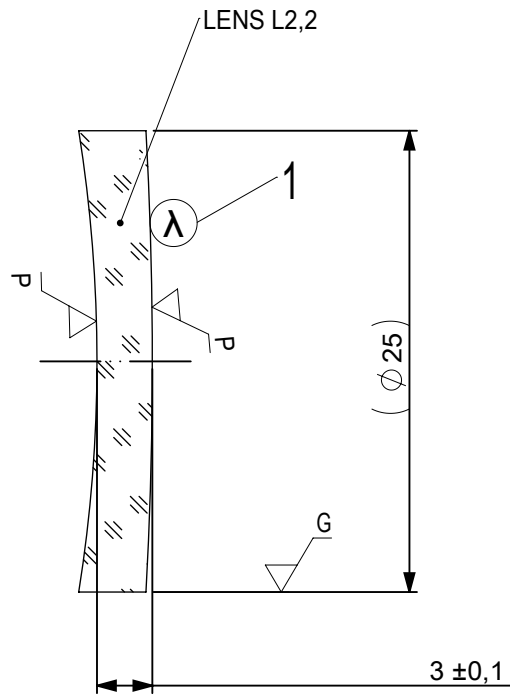

1 AR COATING:

1/4 WAVE MgF2 @ 550nm
 R(AVG) < 1,75% FROM 400-700nm (N-BK7)

LEFT SURFACE	MATERIAL	RIGHT SURFACE
R 79,38±0,079 CV	GLASS N-SF5 673/322	R 226,03±0,226 CX
Øe 24		Øe 24
3/ 3 (0,5) λ=632,8 nm		3/ 3 (0,5) λ=632,8 nm
4/ -		4/ -
5/ 40 - 20 (MIL-PRF-13830B)		5/ 40 - 20 (MIL-PRF-13830B)
6/ -		6/ -

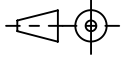
PROTECTIVE CHAMFERS AS NEEDED		FIRST ANGLE PROJECTION	 Edmund Optics®	
ROHS: COMPLIANT	SCALE: NONE λ = 587,6nm			
SPECIFICATIONS SUBJECT TO CHANGE WITHOUT NOTICE. DIMENSIONS ARE FOR REFERENCE ONLY			TITLE	25mm Dia, x 175mm FL, MgF2 Coated, Achromatic Doublet Lens
FOR INFORMATION ONLY: DO NOT MANUFACTURE PARTS TO THIS DRAWING			ALL DIMS IN: mm	DWG NO
INDICATIONS IN ACCORDANCE WITH ISO 10110			SHEET SIZE	A4
			SHEET	3 OF 3