

FOCAL LENGTH (EFL): $150 \pm 1,5$
 BACK FOCAL LENGTH (BFL): 143,9

SURFACE A	SURFACE B	SURFACE C
$\varnothing e 24$	$\varnothing e 24$	$\varnothing e 24$
CEMENT: NOA 61 OR EQUIVALENT		

PROTECTIVE CHAMFERS AS NEEDED		FIRST ANGLE PROJECTION	 Edmund Optics®						
ROHS: COMPLIANT	SCALE: NONE $\lambda = 880\text{nm}$								
SPECIFICATIONS SUBJECT TO CHANGE WITHOUT NOTICE. DIMENSIONS ARE FOR REFERENCE ONLY			TITLE	25mm Dia, x 150mm FL, NIR II Coated, Achromatic Lens					
FOR INFORMATION ONLY: DO NOT MANUFACTURE PARTS TO THIS DRAWING			ALL DIMS IN:	mm	DWG NO	47380	SHEET SIZE	A4	SHEET
INDICATIONS IN ACCORDANCE WITH ISO 10110									

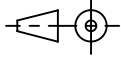
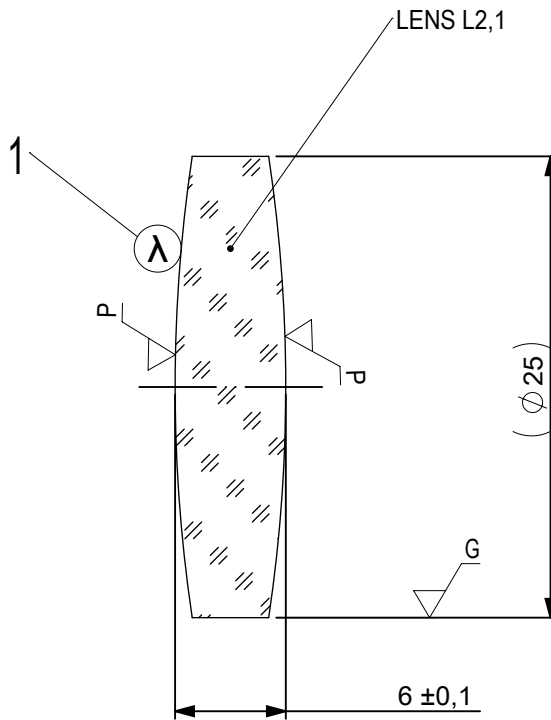

- 1 AR COATING: NIR II
 R(ABS) ≤ 1,5% FROM 750-800nm @ 0° AOI
 R(ABS) ≤ 1,0% FROM 800-1550nm @ 0° AOI
 R(AVG) ≤ 0,7% FROM 750-1550nm @ 0° AOI

LEFT SURFACE	MATERIAL	RIGHT SURFACE
R 84,658±0,085 CX Øe 24 3/ 3 (0,5) λ=632,8 nm 4/ - 5/ 40 - 20 (MIL-PRF-13830B) 6/ -	GLASS N-LaK22 651/559	R 84,658±0,085 CX Øe 24 3/ 3 (0,5) λ=632,8 nm 4/ - 5/ 40 - 20 (MIL-PRF-13830B) 6/ -

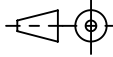
PROTECTIVE CHAMFERS AS NEEDED		FIRST ANGLE PROJECTION			
ROHS: COMPLIANT	SCALE: NONE λ = 880nm				
SPECIFICATIONS SUBJECT TO CHANGE WITHOUT NOTICE. DIMENSIONS ARE FOR REFERENCE ONLY			TITLE	25mm Dia, x 150mm FL, NIR II Coated, Achromatic Lens	
FOR INFORMATION ONLY: DO NOT MANUFACTURE PARTS TO THIS DRAWING			ALL DIMS IN: mm	DWG NO	47380
INDICATIONS IN ACCORDANCE WITH ISO 10110					SHEET 2 OF 3

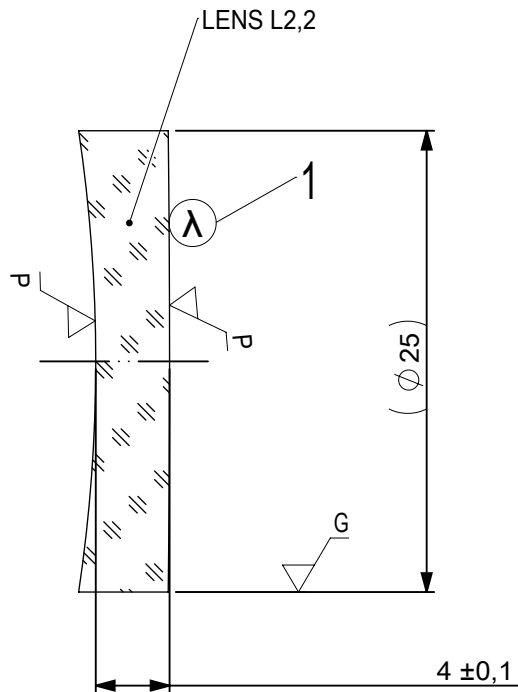

- 1 AR COATING: NIR II
 R(ABS) ≤ 1,5% FROM 750-800nm @ 0° AOI
 R(ABS) ≤ 1,0% FROM 800-1550nm @ 0° AOI
 R(AVG) ≤ 0,7% FROM 750-1550nm @ 0° AOI

LEFT SURFACE	MATERIAL	RIGHT SURFACE
R 84,658±0,085 CV	GLASS N-SF6 805/254	R 1071,908±1,072 CX
Øe 24		Øe 24
3/ 3 (0,5) λ=632,8 nm		3/ 3 (0,5) λ=632,8 nm
4/ -		4/ -
5/ 40 - 20 (MIL-PRF-13830B)		5/ 40 - 20 (MIL-PRF-13830B)
6/ -		6/ -

PROTECTIVE CHAMFERS AS NEEDED

ROHS: COMPLIANT
 SCALE: NONE λ = 880nm

SPECIFICATIONS SUBJECT TO CHANGE WITHOUT NOTICE. DIMENSIONS ARE FOR REFERENCE ONLY

FOR INFORMATION ONLY: DO NOT MANUFACTURE PARTS TO THIS DRAWING

INDICATIONS IN ACCORDANCE WITH ISO 10110

FIRST ANGLE PROJECTION

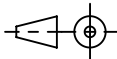

ALL DIMS IN: mm



Edmund Optics®

TITLE

25mm Dia, x 150mm FL, NIR II Coated, Achromatic Lens

DWG NO

47380

SHEET SIZE
A4

SHEET
3 OF 3