

FOCAL LENGTH (EFL): $125 \pm 1,25$
 BACK FOCAL LENGTH (BFL): 120,89

SURFACE A	SURFACE B	SURFACE C
$\phi_e 24$	$\phi_e 24$	$\phi_e 24$
CEMENT: NOA 61 OR EQUIVALENT		

PROTECTIVE CHAMFERS AS NEEDED		FIRST ANGLE PROJECTION			
ROHS: COMPLIANT	SCALE: NONE $\lambda = 587,6\text{nm}$				
SPECIFICATIONS SUBJECT TO CHANGE WITHOUT NOTICE. DIMENSIONS ARE FOR REFERENCE ONLY			TITLE 25mm Dia, x 125mm FL, VIS 0 Coated, Achromatic Lens		
FOR INFORMATION ONLY: DO NOT MANUFACTURE PARTS TO THIS DRAWING			ALL DIMS IN: mm	DWG NO 47642	SHEET SIZE A4
INDICATIONS IN ACCORDANCE WITH ISO 10110					

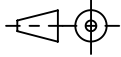
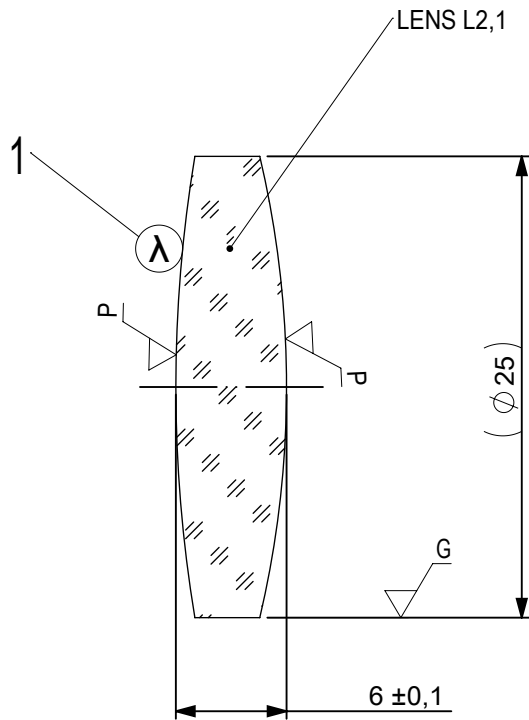

1 AR COATING: VIS 0°
R(AVG) ≤ 0,4% FROM 425-675nm @ 0° AOI

LEFT SURFACE	MATERIAL	RIGHT SURFACE
R 76,28±0,076 CX Øe 24 3/ 3 (0,5) λ=632,8 nm 4/ - 5/ 40 - 20 (MIL-PRF-13830B) 6/ -	GLASS N-BK7 517/642	R 54,55±0,055 CX Øe 24 3/ 3 (0,5) λ=632,8 nm 4/ - 5/ 40 - 20 (MIL-PRF-13830B) 6/ -

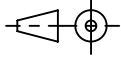
PROTECTIVE CHAMFERS AS NEEDED		FIRST ANGLE PROJECTION	 Edmund Optics®		
ROHS: COMPLIANT	SCALE: NONE λ = 587,6nm				
SPECIFICATIONS SUBJECT TO CHANGE WITHOUT NOTICE. DIMENSIONS ARE FOR REFERENCE ONLY			TITLE	25mm Dia, x 125mm FL, VIS 0 Coated, Achromatic Lens	
FOR INFORMATION ONLY: DO NOT MANUFACTURE PARTS TO THIS DRAWING			ALL DIMS IN: mm	DWG NO	47642
INDICATIONS IN ACCORDANCE WITH ISO 10110					SHEET 2 OF 3

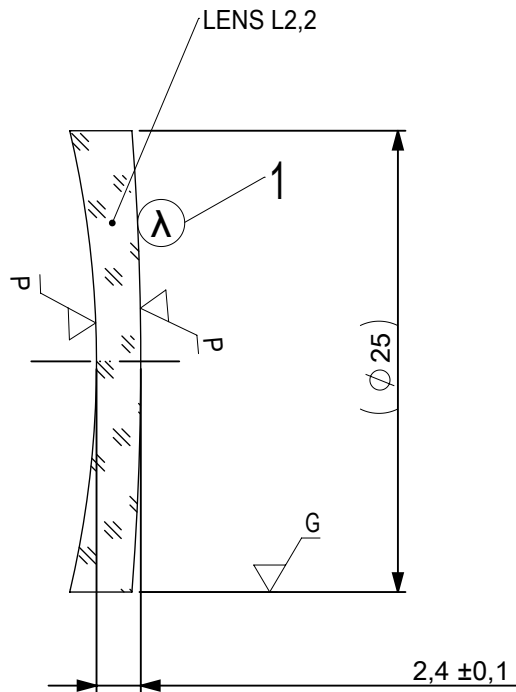

1 AR COATING: VIS 0°
R(AVG) ≤ 0,4% FROM 425-675nm @ 0° AOI

LEFT SURFACE	MATERIAL	RIGHT SURFACE
R 54,55±0,055 CV	GLASS N-SF5 673/322	R 162,43±0,162 CX
Øe 24		Øe 24
3/ 3 (0,5) λ=632,8 nm		3/ 3 (0,5) λ=632,8 nm
4/ -		4/ -
5/ 40 - 20 (MIL-PRF-13830B)		5/ 40 - 20 (MIL-PRF-13830B)
6/ -		6/ -

PROTECTIVE CHAMFERS AS NEEDED

ROHS: COMPLIANT SCALE: NONE λ = 587,6nm

SPECIFICATIONS SUBJECT TO CHANGE WITHOUT NOTICE. DIMENSIONS ARE FOR REFERENCE ONLY

FOR INFORMATION ONLY: DO NOT MANUFACTURE PARTS TO THIS DRAWING

INDICATIONS IN ACCORDANCE WITH ISO 10110

FIRST ANGLE PROJECTION

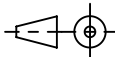

ALL DIMS IN: mm

EO® Edmund Optics®

TITLE 25mm Dia, x 125mm FL, VIS 0 Coated, Achromatic Lens

DWG NO 47642

SHEET SIZE A4 SHEET 3 OF 3