

FOCAL LENGTH (EFL):  $60 \pm 0,6$   
 BACK FOCAL LENGTH (BFL): 58,46

SURFACE A	SURFACE B	SURFACE C
$\varnothing e 5,625$	$\varnothing e 5,625$	$\varnothing e 5,625$
CEMENT: NOA 61 OR EQUIVALENT		

PROTECTIVE CHAMFERS AS NEEDED		FIRST ANGLE PROJECTION	 <b>Edmund Optics<sup>®</sup></b>			
ROHS: COMPLIANT	SCALE: NONE $\lambda = 587,6\text{nm}$					
SPECIFICATIONS SUBJECT TO CHANGE WITHOUT NOTICE. DIMENSIONS ARE FOR REFERENCE ONLY			TITLE	6,25mm Dia, x 60mm FL, VIS 0 Coated, Achromatic Lens		
FOR INFORMATION ONLY: DO NOT MANUFACTURE PARTS TO THIS DRAWING			ALL DIMS IN:	mm	DWG NO	
INDICATIONS IN ACCORDANCE WITH ISO 10110				47698	SHEET SIZE <b>A4</b>	SHEET 1 OF 3

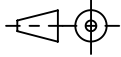
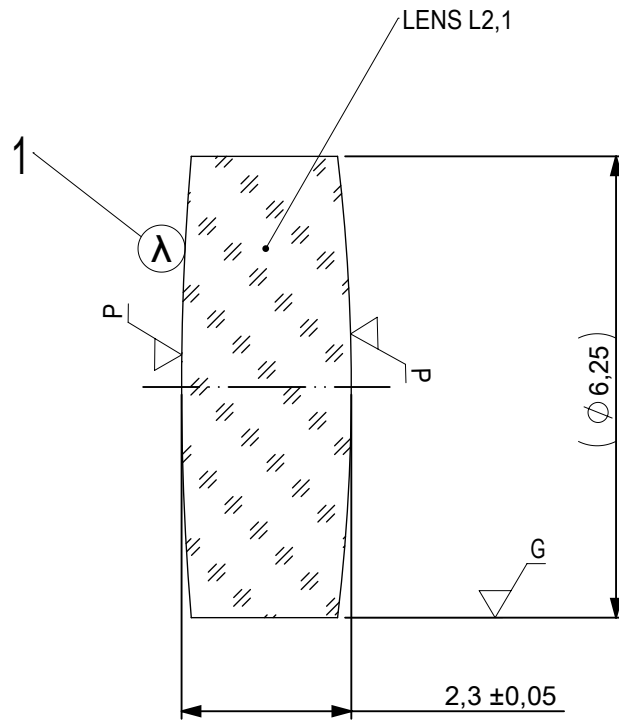

1 AR COATING: VIS 0°  
R(AVG) ≤ 0,4% FROM 425-675nm @ 0° AOI

LEFT SURFACE	MATERIAL	RIGHT SURFACE
R 37,16±0,037 CX Øe 5,625 3/ 3 (0,5) λ=632,8 nm 4/ - 5/ 40 - 20 (MIL-PRF-13830B) 6/ -	GLASS N-BK7 517/642	R 26,28±0,026 CX Øe 5,625 3/ 3 (0,5) λ=632,8 nm 4/ - 5/ 40 - 20 (MIL-PRF-13830B) 6/ -

PROTECTIVE CHAMFERS AS NEEDED

ROHS: COMPLIANT      SCALE: NONE      λ = 587,6nm

SPECIFICATIONS SUBJECT TO CHANGE WITHOUT NOTICE. DIMENSIONS ARE FOR REFERENCE ONLY

FOR INFORMATION ONLY: DO NOT MANUFACTURE PARTS TO THIS DRAWING

INDICATIONS IN ACCORDANCE WITH ISO 10110

FIRST ANGLE PROJECTION

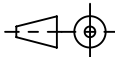

ALL DIMS IN: mm



Edmund Optics®

TITLE

6,25mm Dia, x 60mm FL, VIS 0 Coated, Achromatic Lens

DWG NO

47698

SHEET SIZE  
A4

SHEET  
2 OF 3

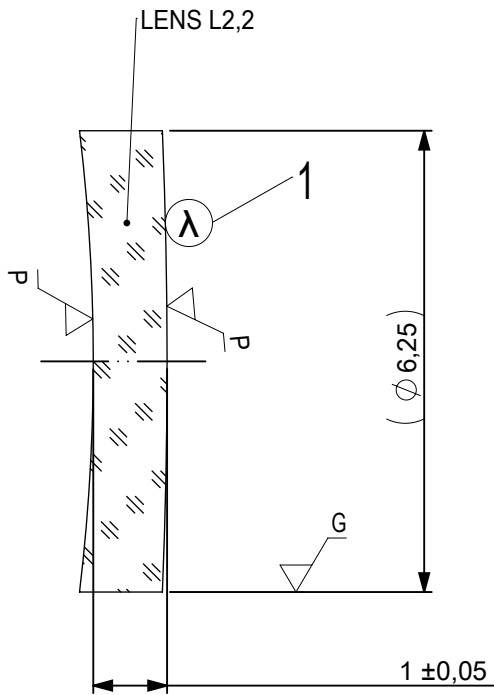

1 AR COATING: VIS 0°  
R(AVG) ≤ 0,4% FROM 425-675nm @ 0° AOI

LEFT SURFACE	MATERIAL	RIGHT SURFACE
R 26,28±0,026 CV Øe 5,625 3/ 3 (0,5) λ=632,8 nm 4/ - 5/ 40 - 20 (MIL-PRF-13830B) 6/ -	GLASS N-SF5 673/322	R 76,48±0,076 CX Øe 5,625 3/ 3 (0,5) λ=632,8 nm 4/ - 5/ 40 - 20 (MIL-PRF-13830B) 6/ -

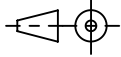
PROTECTIVE CHAMFERS AS NEEDED		FIRST ANGLE PROJECTION			
ROHS: COMPLIANT	SCALE: NONE λ = 587,6nm				
SPECIFICATIONS SUBJECT TO CHANGE WITHOUT NOTICE. DIMENSIONS ARE FOR REFERENCE ONLY			TITLE	6,25mm Dia, x 60mm FL, VIS 0 Coated, Achromatic Lens	
FOR INFORMATION ONLY: DO NOT MANUFACTURE PARTS TO THIS DRAWING			ALL DIMS IN: mm	DWG NO	47698
INDICATIONS IN ACCORDANCE WITH ISO 10110					SHEET 3 OF 3