

FOCAL LENGTH (EFL): 300 ±3
 BACK FOCAL LENGTH (BFL): 293,63

SURFACE A	SURFACE B	SURFACE C
Øe 39	Øe 39	Øe 39
CEMENT: NOA 61 OR EQUIVALENT		

PROTECTIVE CHAMFERS AS NEEDED		FIRST ANGLE PROJECTION	 Edmund Optics®	
ROHS: COMPLIANT	SCALE: NONE $\lambda = 587,6\text{nm}$			
SPECIFICATIONS SUBJECT TO CHANGE WITHOUT NOTICE. DIMENSIONS ARE FOR REFERENCE ONLY			TITLE 40mm Dia, x 300mm FL, VIS-NIR Coated, Achromatic Lens	
FOR INFORMATION ONLY: DO NOT MANUFACTURE PARTS TO THIS DRAWING			ALL DIMS IN: mm	DWG NO 49385
INDICATIONS IN ACCORDANCE WITH ISO 10110				SHEET 1 OF 3

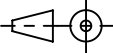
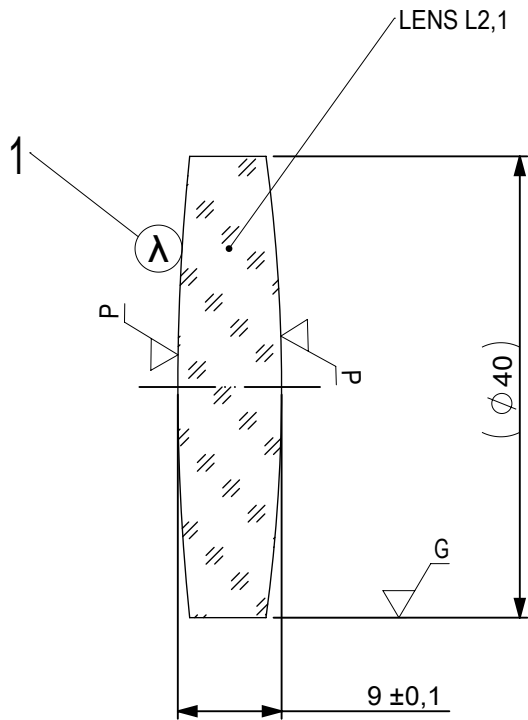

- 1 AR COATING: VIS-NIR
 R(ABS) ≤ 0,25% AT 880nm @ 0° AOI
 R(AVG) ≤ 1,25% FROM 400-870nm @ 0° AOI
 R(AVG) ≤ 1,25% FROM 890-1000nm @ 0° AOI

LEFT SURFACE	MATERIAL	RIGHT SURFACE
R 194,96±0,195 CX Øe 39 3/ 3 (0,5) λ=632,8 nm 4/ - 5/ 40 - 20 (MIL-PRF-13830B) 6/ -	GLASS N-BaK4 569/561	R 148,27±0,148 CX Øe 39 3/ 3 (0,5) λ=632,8 nm 4/ - 5/ 40 - 20 (MIL-PRF-13830B) 6/ -

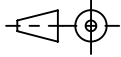
PROTECTIVE CHAMFERS AS NEEDED		FIRST ANGLE PROJECTION	 Edmund Optics®	
ROHS: COMPLIANT	SCALE: NONE λ = 587,6nm			
SPECIFICATIONS SUBJECT TO CHANGE WITHOUT NOTICE. DIMENSIONS ARE FOR REFERENCE ONLY			TITLE	40mm Dia, x 300mm FL, VIS-NIR Coated, Achromatic Lens
FOR INFORMATION ONLY: DO NOT MANUFACTURE PARTS TO THIS DRAWING			ALL DIMS IN: mm	DWG NO
INDICATIONS IN ACCORDANCE WITH ISO 10110			SHEET SIZE	A4
				SHEET 2 OF 3

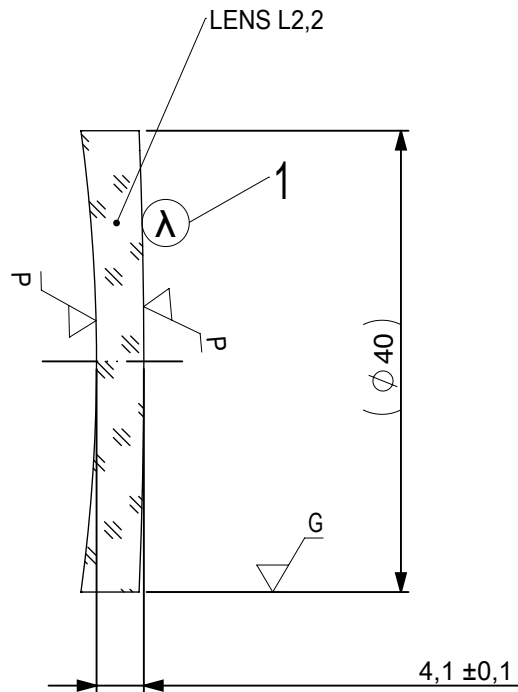

- 1 AR COATING: VIS-NIR
 R(ABS) ≤ 0,25% AT 880nm @ 0° AOI
 R(AVG) ≤ 1,25% FROM 400-870nm @ 0° AOI
 R(AVG) ≤ 1,25% FROM 890-1000nm @ 0° AOI

LEFT SURFACE	MATERIAL	RIGHT SURFACE
R 148,27±0,148 CV	GLASS N-SF10 728/284	R 483,71±0,484 CX
Øe 39		Øe 39
3/ 3 (0,5) λ=632,8 nm		3/ 3 (0,5) λ=632,8 nm
4/ -		4/ -
5/ 40 - 20 (MIL-PRF-13830B)		5/ 40 - 20 (MIL-PRF-13830B)
6/ -		6/ -

PROTECTIVE CHAMFERS AS NEEDED

ROHS: COMPLIANT
 SCALE: NONE λ = 587,6nm

SPECIFICATIONS SUBJECT TO CHANGE WITHOUT NOTICE. DIMENSIONS ARE FOR REFERENCE ONLY

FOR INFORMATION ONLY: DO NOT MANUFACTURE PARTS TO THIS DRAWING

INDICATIONS IN ACCORDANCE WITH ISO 10110

FIRST ANGLE PROJECTION

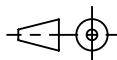

ALL DIMS IN: mm



Edmund Optics®

TITLE 40mm Dia, x 300mm FL, VIS-NIR Coated, Achromatic Lens

DWG NO 49385

SHEET SIZE A4

SHEET 3 OF 3