

NOTES:
 1. RoHS: COMPLIANT

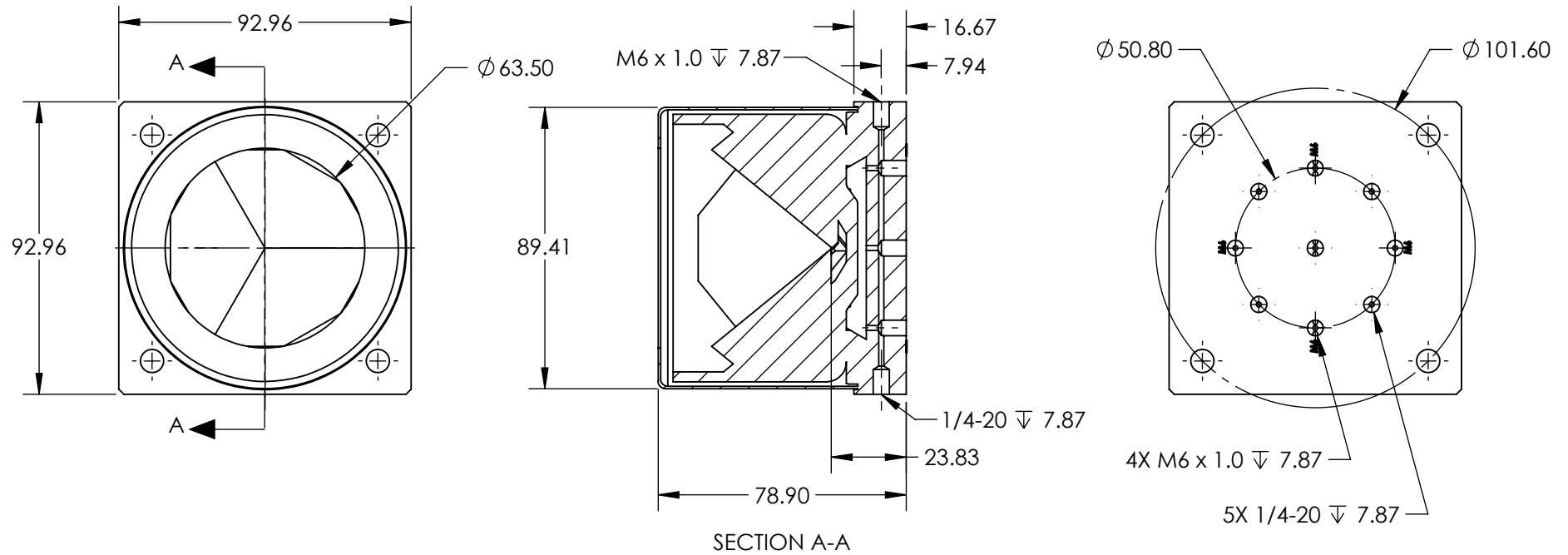

SPECIFICATIONS SUBJECT TO CHANGE WITHOUT NOTICE
 DIMENSIONS ARE FOR REFERENCE ONLY

**FOR INFORMATION ONLY:
 DO NOT MANUFACTURE
 PARTS TO THIS DRAWING**

EO[®] Edmund Optics[®]

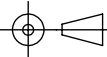
THIRD ANGLE PROJECTION 		TITLE	63.5mm Clear Aperture, 1 Arcsec, Aluminum Retroreflector	
ALL DIMS IN	mm	DWG NO	46176	SHEET 1 OF 1