

**FOR INFORMATION ONLY:
DO NOT MANUFACTURE
PARTS TO THIS DRAWING**

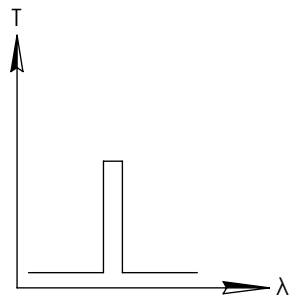
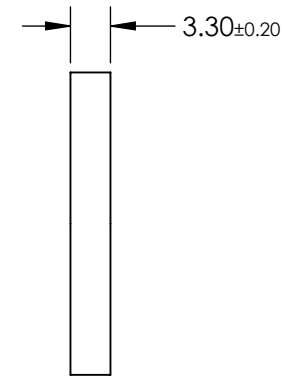
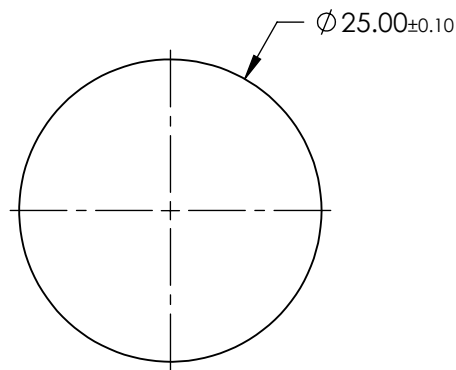
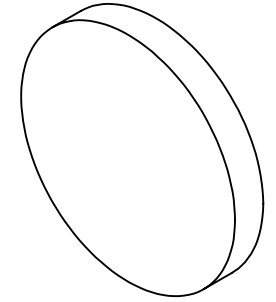

BANDPASS FILTER

	VALUE
CENTER WAVELENGTH (CWL)	450 ± 5nm
FULL WIDTH HALF MAX (FWHM)	50.0 ± 5nm
MINIMUM TRANSMISSION	≥90%
BLOCKING	200 - 1200nm
CLEAR APERTURE (mm)	Ø22.50
SURFACE QUALITY	80-50
COATING TYPE	HARD COATED
DURABILITY	MIL-C-48497A, SECTION 3.4.1
ENVIRONMENTAL	MIL-STD-810F, SECTION 507.4

SPECIFICATIONS SUBJECT TO CHANGE WITHOUT NOTICE
DIMENSIONS ARE FOR REFERENCE ONLY



THIRD ANGLE PROJECTION		TITLE	450nm CWL, 25mm DIA., HARD COATED OD 4.0 50nm UNMOUNTED BANDPASS FILTER
ALL DIMS IN	mm	DWG NO	15164
			SHEET 1 OF 1