

**FOR INFORMATION ONLY:
DO NOT MANUFACTURE
PARTS TO THIS DRAWING**

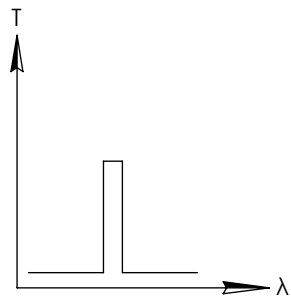

BANDPASS FILTER

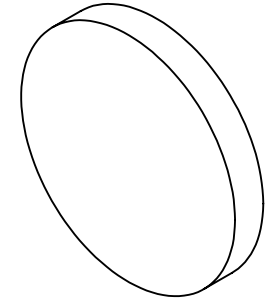
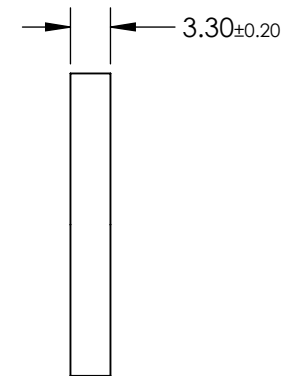
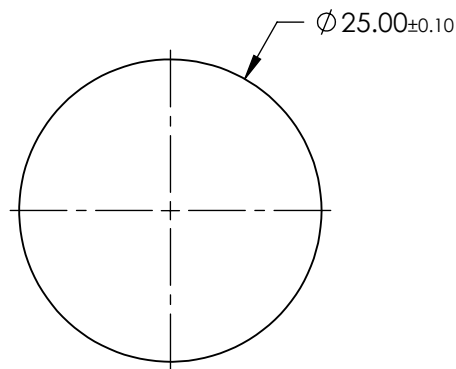

	VALUE
CENTER WAVELENGTH (CWL)	550 ± 5nm
FULL WIDTH HALF MAX (FWHM)	50.0 ± 5nm
MINIMUM TRANSMISSION	≥90%
BLOCKING	200 - 1200nm
CLEAR APERTURE (mm)	Ø22.50
SURFACE QUALITY	80-50
COATING TYPE	HARD COATED
DURABILITY	MIL-C-48497A, SECTION 3.4.1
ENVIRONMENTAL	MIL-STD-810F, SECTION 507.4

SPECIFICATIONS SUBJECT TO CHANGE WITHOUT NOTICE
DIMENSIONS ARE FOR REFERENCE ONLY

EO® **Edmund Optics**®

THIRD ANGLE PROJECTION		TITLE	550nm CWL, 25mm DIA., HARD COATED OD 4.0 50nm UNMOUNTED BANDPASS FILTER	
ALL DIMS IN	mm	DWG NO	15166	SHEET 1 OF 1