

**FOR INFORMATION ONLY:
DO NOT MANUFACTURE
PARTS TO THIS DRAWING**

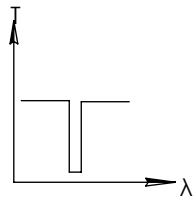
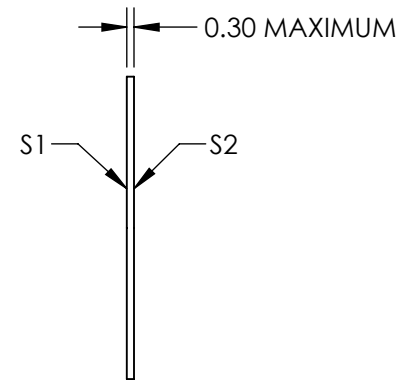
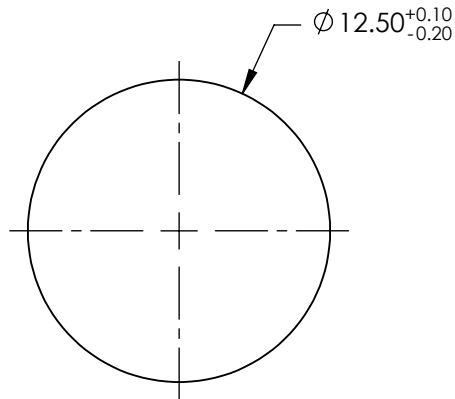
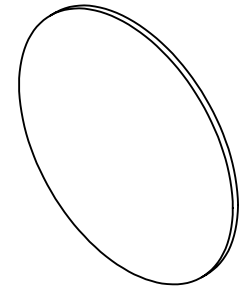

NOTCH FILTER

SPECIFICATIONS SUBJECT TO CHANGE WITHOUT NOTICE
DIMENSIONS ARE FOR REFERENCE ONLY

	VALUE
CLEAR APERTURE	$\varnothing 11.50$
CENTER WAVELENGTH	$633 \pm 12.66 \text{ nm}$
FULL WIDTH HALF MAX (FWHM)	$\leq 50.64 \text{ nm}$
OPTICAL DENSITY	≥ 6.0
TRANSMISSION	$\geq 85\%$

EO® Edmund Optics®

THIRD ANGLE
PROJECTION

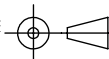

TITLE

633nm, 12.5 mm Dia., OD 6.0 Ultra-Thin Notch
Filter

ALL DIMS IN

mm

DWG NO

14759

SHEET
1 OF 1